

ORIGINAL ARTICLES

Compact MIMO Antenna for 4G Transceiver Application

Islam E. Kotb, Reda S. Ghoname, Hussein H. Ghouz and Hani H. Kaldass

*Arab Academy for Science and Technology and Maritime Transport, Al- Horria, Heliopolis, Cairo, Egypt.
 Electronics Research Center, Dokki, Cairo, Egypt.*

ABSTRACT

A design for a novel microstrip planar MIMO antenna for 4G application is presented. A decoupling network is added to improve the MIMO antenna ports isolation. The decoupling network is compact and consists of two elements having similar dimensions. The MIMO antenna resonates at 5.1GHz, 5.29GHz, 6GHz, 6.1GHz, 11.4GHz and 11.92GHz. The MIMO antenna exhibits good isolation below -20 dB at the required bands which reduces the mutual coupling between the antenna ports. A prototype of the MIMO antenna system was fabricated using thin film and photolithographic technique, and then measured by using vector network analyzer. Good agreement was found between the simulated and measured results.

Key words: 4G, SISO, MIMO

Introduction

The increasing demand for higher data rates in mobile services presented a big challenge for communication engineers. Fourth generation (4G) technology, such as Worldwide Interoperability for Microwave Access (WiMax), rely on multiple antenna systems, referred to as multiple-input-multiple-output (MIMO) systems, rather than the classical single-input-single-output (SISO) systems. The technique of improving channel capacity by employing multiple antennas at both the transmitter and receiver was first predicted by Foschini (Foschini and Gans, 1998).

The basic principle beyond MIMO antenna design is to reduce the mutual coupling between the ports of the antenna. This can be achieved by employing diversity techniques (Sanchez, 2008), use of decoupling networks and defective ground structures (KIM and Ahn, 2007). The mutual coupling mainly depends on the separation between the elements of the MIMO system, and is reduced by increasing the separation between them. However, this distance is limited due to the small area in which the elements are placed.

In this paper, we present a design of a novel compact microstrip planar MIMO antenna system suitable for 4G application. A decoupling network is introduced to improve the antenna ports isolation. Details of the MIMO antenna design, simulation and measurement results are presented.

Methodology:

Single Port Configuration:

The proposed structure by (Trang *et al.*, 2011), achieves ultra wideband from 17-30GHz, having the antenna feed position at the center of the arc. The implementation of partial ground and allocation of slots (Cohn, 1996) on the patch allows the antenna to generate different frequency bands. In our proposed structure shown in Fig. 1, by changing the antenna feed position along the arc and using different substrate material, the same frequency bands can be generated. By placing VIA's at different positions on the patch, the antenna can be tuned to operate in the S-band, C-band and X-band. The proposed antenna has a circumference 52 mm. The structure consists of a rectangular patch sitting on a circular sector. FR-4 substrate was used with $\epsilon_r = 4.65$ and $h = 1.6$ mm. The overall dimension of the substrate simulating the ground plane for the antenna is 35 x 32 mm².

MIMO Antenna Configuration without Decoupling Network:

Fig. 2 below shows the multiport configuration of the antenna. The antenna consists of three ports, with port 1 and port 2 being symmetric on the sides of the patch. Port 3 is placed at the center of the arc. MIMO antenna acts as two transmitters and one receiver or two receivers and one transmitter. To improve the antenna ports isolation, a decoupling network was designed using the same substrate material as shown in Fig. 3. The two

elements of the decoupling network have similar dimensions and can be changed to change the pass band frequencies. The separation (d) between the elements can be changed to improve the MIMO antenna ports isolation.

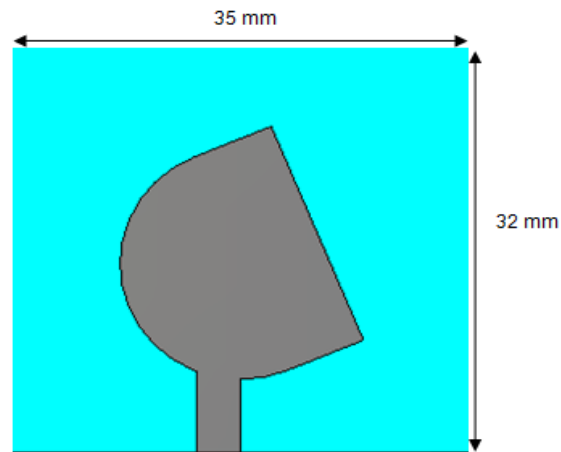

Fig. 1: Geometry of single port antenna.

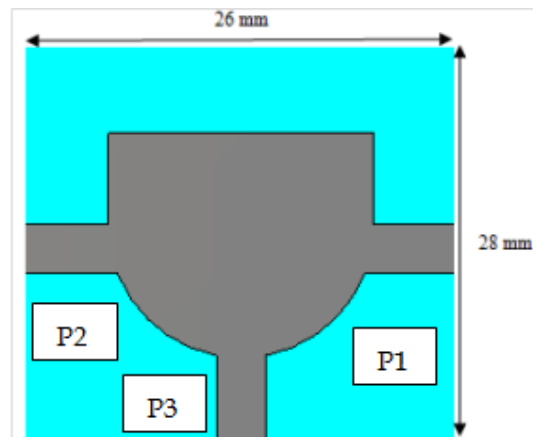

Fig. 2: MIMO antenna configuration.

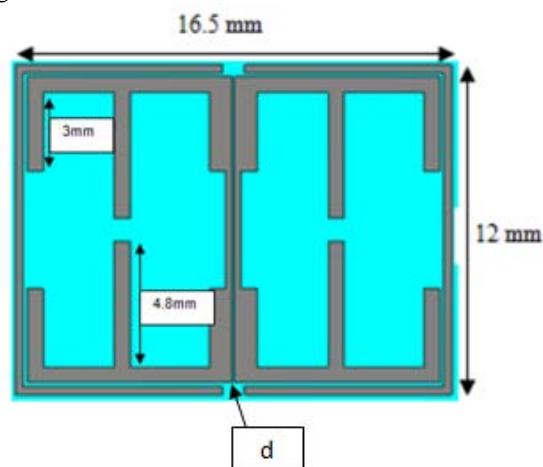

Fig. 3: Geometry of decoupling network.

MIMO Antenna Configuration with Decoupling Network:

Fig. 4 below shows the fabricated prototype of the MIMO antenna employing the decoupling network. The antenna was fabricated using thin film and photolithographic technique. The networks are placed at the feed

lines of the MIMO antenna. The MIMO antenna was measured using the vector network analyzer. The overall dimension of the MIMO antenna system is $68 \times 50 \text{ mm}^2$.

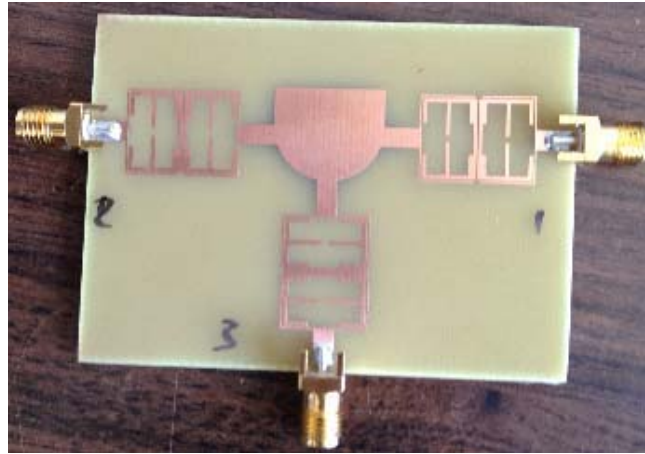

Fig. 4: Fabricated MIMO antenna employing decoupling network.

Results and Discussion

The simulated reflection coefficient for the single port antenna is shown in Fig. 5. The antenna resonates at 5.15GHz and 8.14GHz. The simulated reflection coefficient and insertion loss for the MIMO antenna without the decoupling network is shown in Fig. 6. The antenna resonates at 4.92GHz and 8.85GHz.

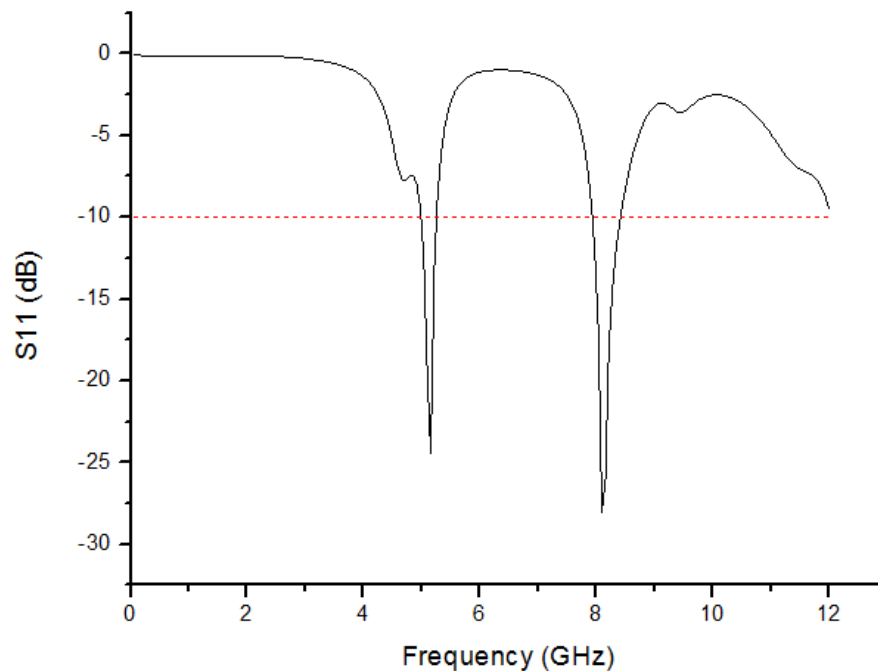

Fig. 5: Simulated reflection coefficient for single port antenna.

As shown in Fig. 6, the reflection coefficients for port 1 and port 2 (S_{11} & S_{22}) match each other. This is due to the symmetry of their locations along the arc. The MIMO antenna can be configured so that ports 1 and 2 can both transmit with port 3 receiving, or viceversa. Also port 1 or port 2 can be terminated with a matched load. The mutual coupling S_{13} and S_{23} is below -20dB at the desired frequency bands, but no resonance for port 1 (S_{33}) is achieved.

Fig. 7 shows the simulated S-parameters for the decoupling network. The simulated and measured S-parameters for the MIMO antenna system employing the decoupling network are shown in Fig. 8 and Fig. 9 respectively. The measured VSWR is shown in Fig. 10.

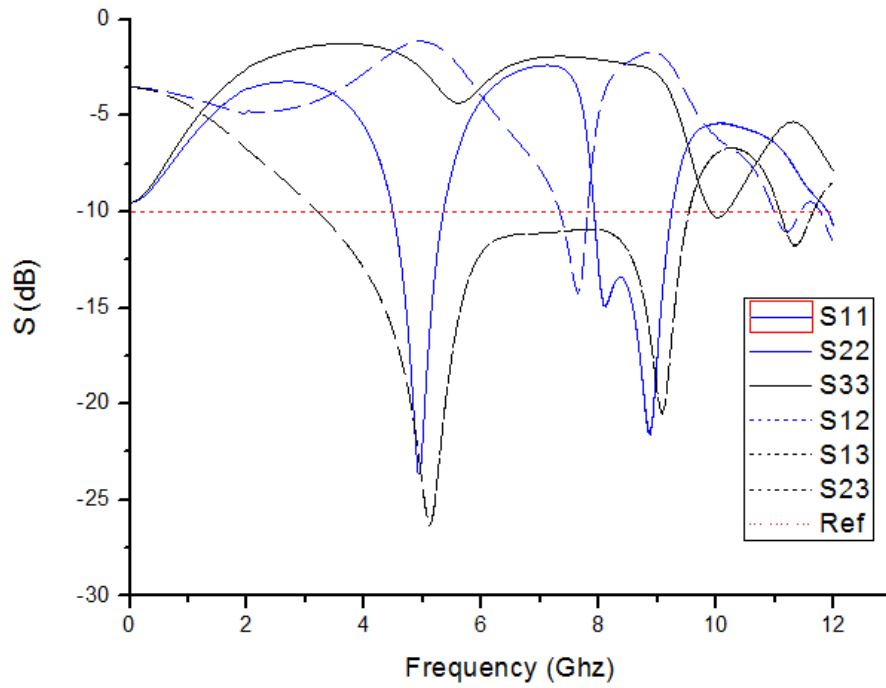

Fig. 6: Simulated reflection coefficient and insertion loss for MIMO antenna.

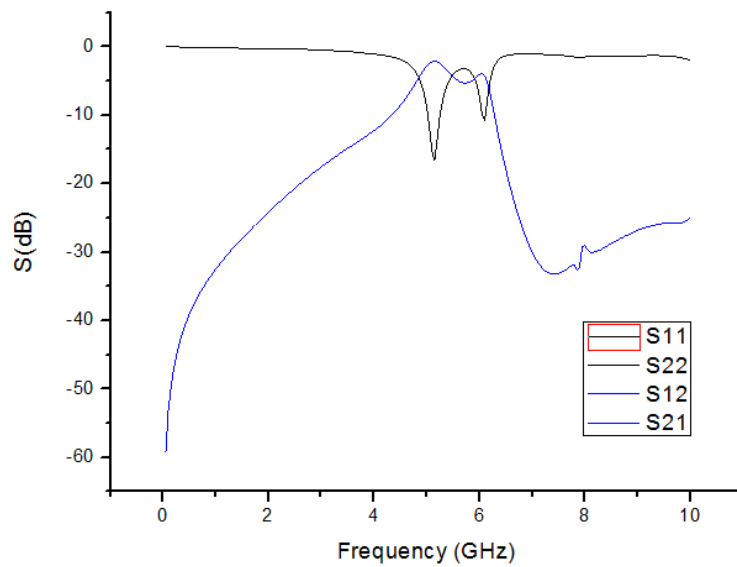

Fig. 7: Simulated S-parameters for the decoupling network.

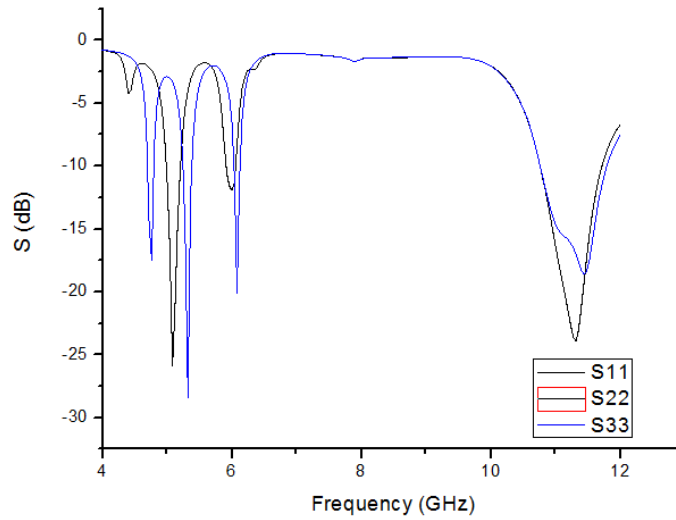

Fig. 8: Simulated reflection coefficient for MIMO antenna with decoupling network.

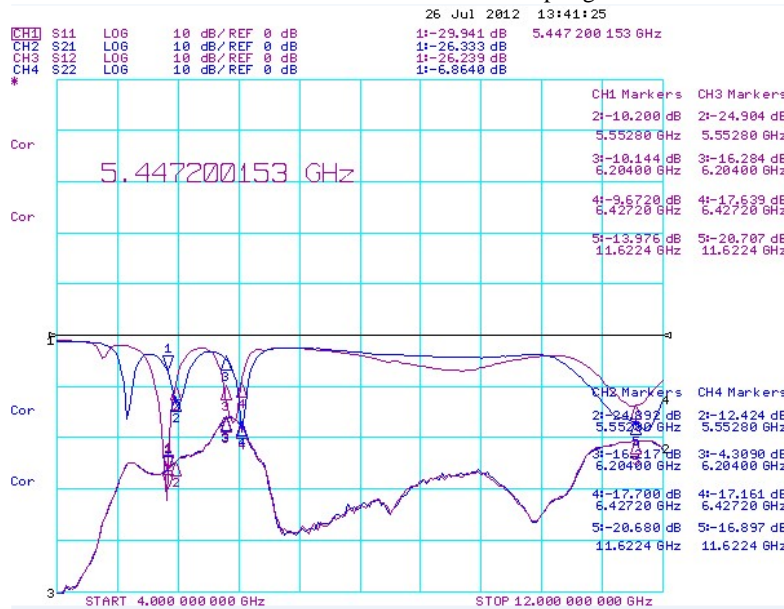

Fig. 9: Measured reflection coefficient and insertion loss for the MIMO antenna with decoupling network.

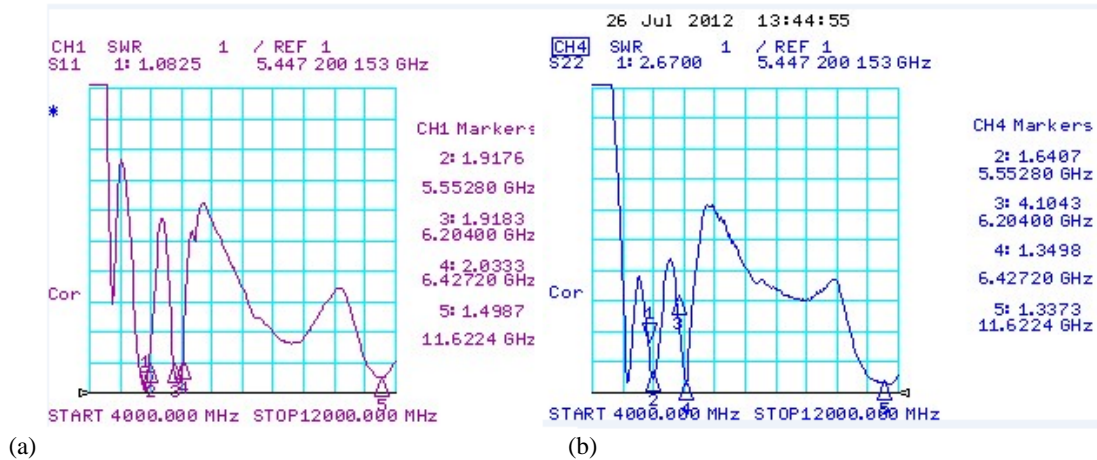

Fig. 10: Measured VSWR (a) Port 1 and Port 2, (b) Port 3

Conclusion:

A design for a planar compact microstrip MIMO antenna was presented. A decoupling network was introduced to improve the antenna ports isolation. The MIMO antenna was fabricated using FR-4 substrate having an overall volume $68 \times 50 \times 1.6 \text{ mm}^3$. The simulated and measured results for the S-parameters and VSWR were presented. Good agreement was found between the measured and simulated results.

References

- Cohn, S.B., 1969. "Slot line on a dielectric substrate", *IEEE Trans. Microw. Theor. Tech.*, MTT-17(10): 768-778.
- Foschini, G.J. and M.J. Gans, 1998. "On limits of wireless communications in fading environment when using multiple antennas", *Wirel. Pers. Commun.*, 6(3): 311-335.
- Kim, K.J. and K.H. Ahn, 2007. "The high isolation dual-band inverted F antenna diversity system with the small N-section resonators on the ground plane", *Microw. Opt. Technol. Lett.*, 49(3): 731-734.
- Sanchez-Hernandez, D.A., 2008. "Multiband integrated antennas for 4G terminals", Artech house Inc, London.
- Trang Dang Ngugen, Dang Hyun Lee, and Hyun Chang Park, 2011. "Design and analysis of compact printed triple band notched UWB antenna", *IEEE antennas and wireless Propagation letters*.