

Electrical Machines I

Week 7-8: DC generators connections, characteristics and theory of operation

Working Principle of DC generator

Mechanical energy is converted to electrical energy

Three requirements are essential

1. Conductors
2. Magnetic field
3. Mechanical energy

An alternating AC current is produced by rotating a loop in a constant magnetic field

Current on left is outward by right-hand rule

The right segment has an inward current

Faraday's Law: If a wire moves through magnetic field, a voltage is induced in it

- A potential difference is maintained across the conductor as long as there is motion through the field
- If motion is reversed, polarity of potential difference is also reversed

$$e = (v \times B) \cdot l$$

Lecture 1



Rotating Loop in B-field

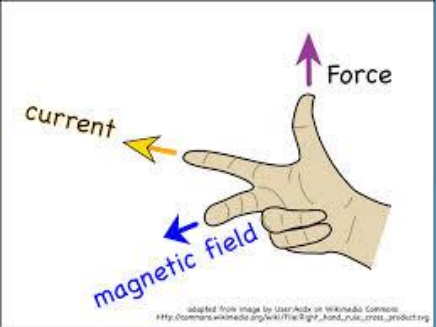
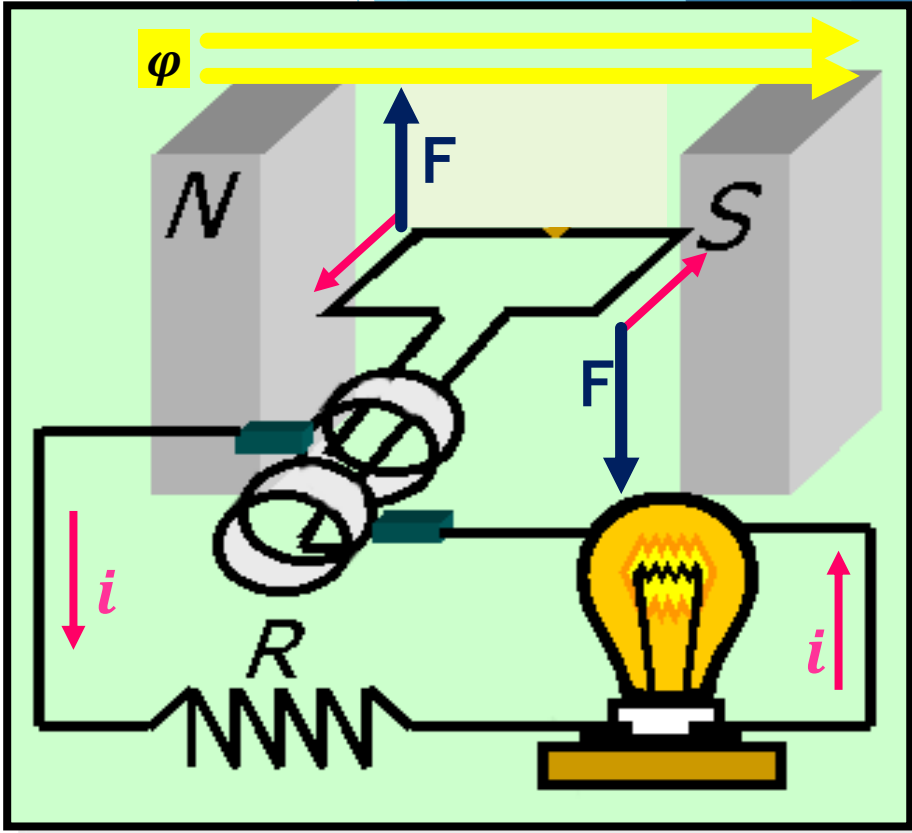

adapted from image by User:Acta on Wikimedia Commons
http://commons.wikimedia.org/wiki/File:RHR.png

Working Principle of DC generator

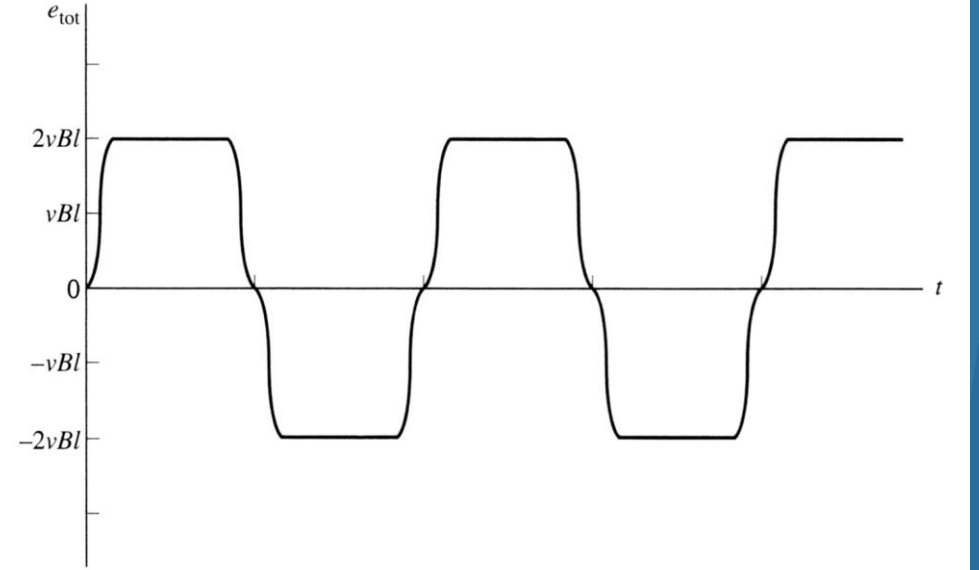
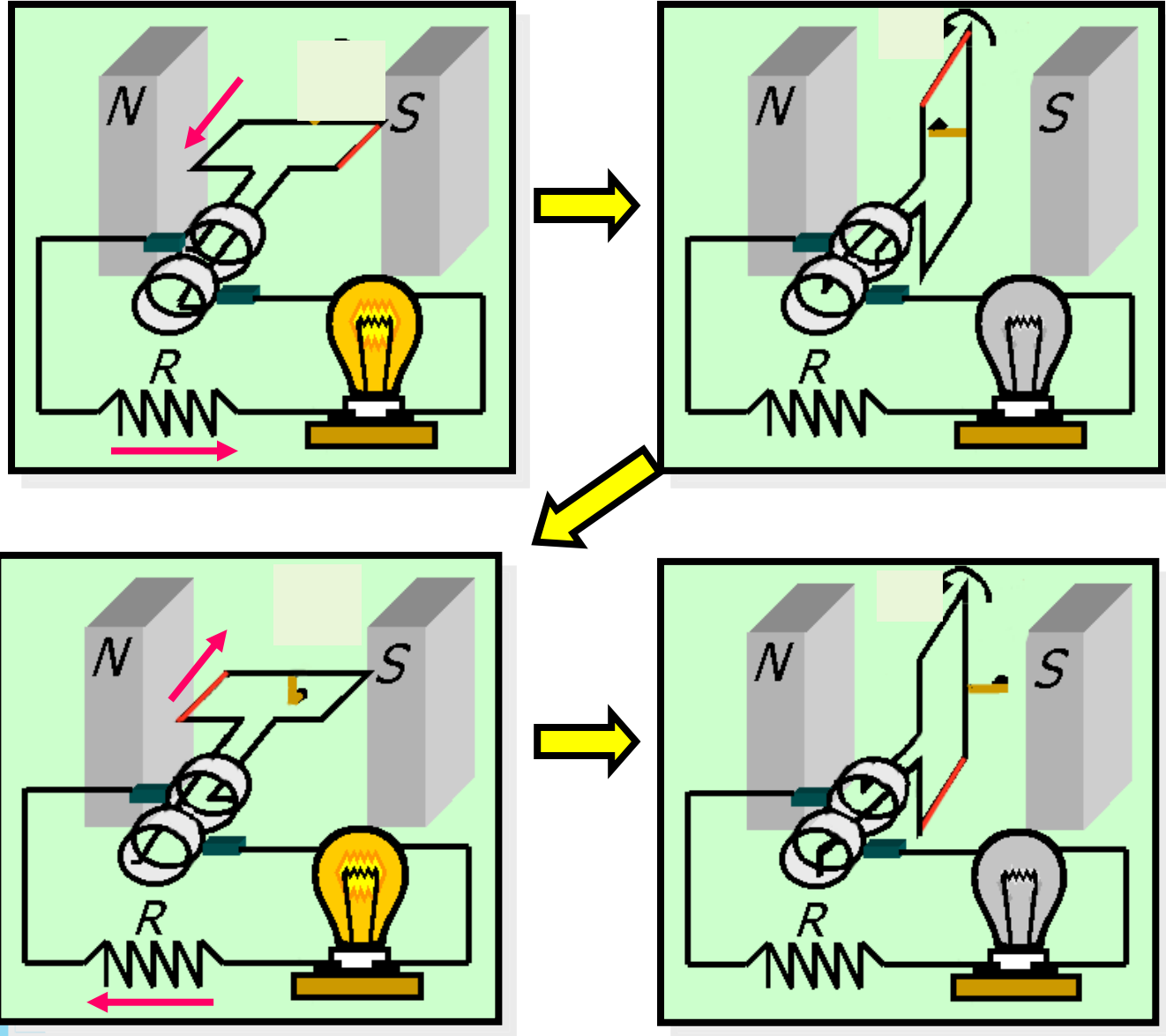

The total induced voltage on the loop is:

$$e_{total} = \begin{cases} 2vBl & \text{under the pole face} \\ 0 & \text{away from the pole face} \end{cases}$$

DC generator Connections:

There are five major types of dc generators, classified according to the manner in which their field flux is produced:

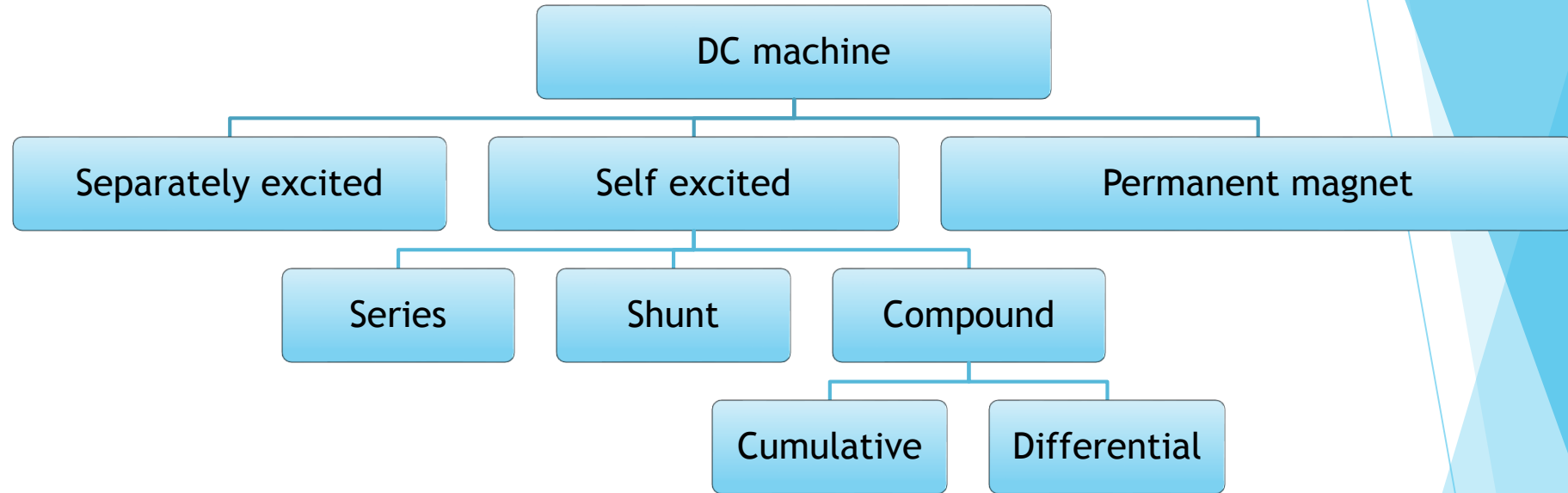

- ❑ ALL generators are driven by a mechanical force, usually called as a prime mover. A prime mover may be a diesel engine, steam turbine, or even an electric motor.
- ❑ DC generators are quite rare in modern power systems. Even dc power systems such as those in automobiles now use ac generators plus rectifiers to produce dc power.

DC generator Connections: Separately Excited DC Generator

Field flux is derived from a separate power source independent of the generator itself

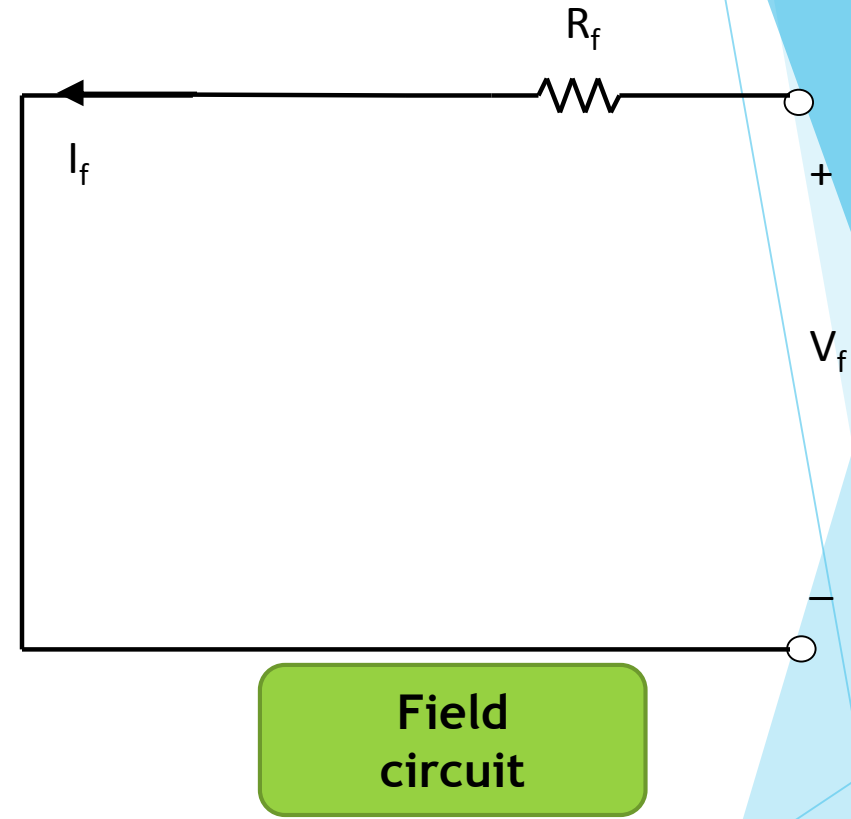
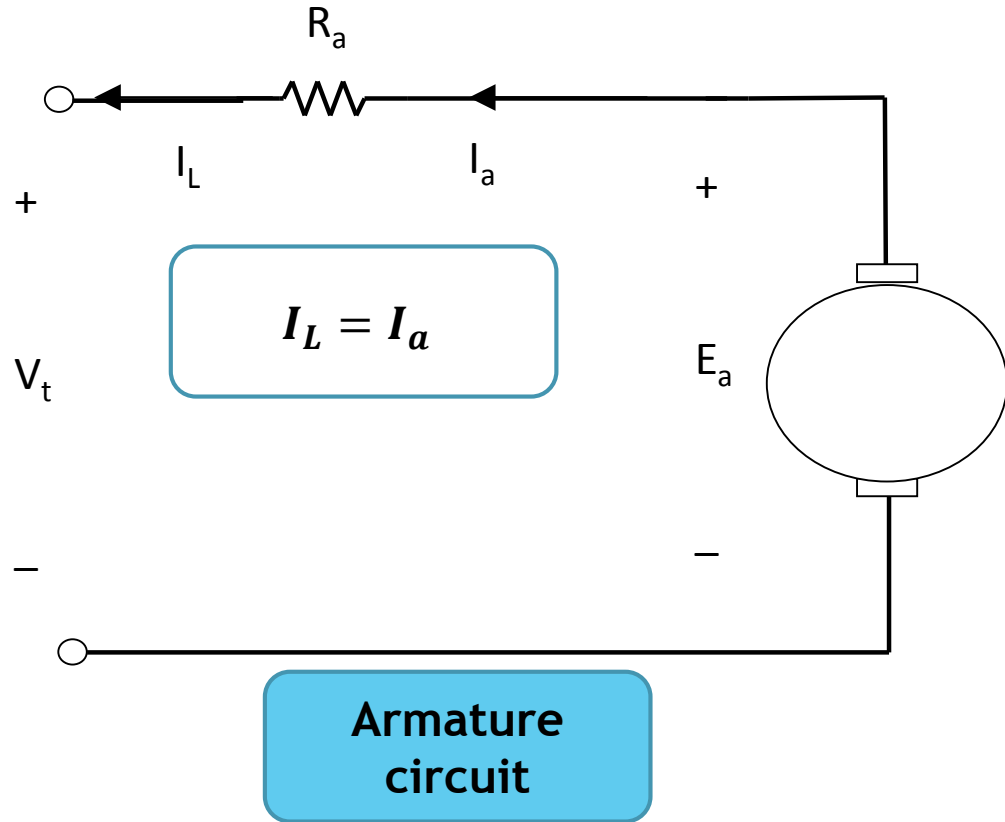

- ❑ V_t is the actual voltage measured at the terminals of the generator.
- ❑ I_L is the current flowing in the lines connected to the terminals.
- ❑ E_a is the internal generated voltage, and I_a is the armature current.

- ❑ R_f equivalent resistance of the field coil.
- ❑ V_f supply voltage for field winding.
- ❑ R_a equivalent resistance of the field armature winding.

DC generator Connections: Separately Excited DC Generator

Field flux is derived from a separate power source independent of the generator itself

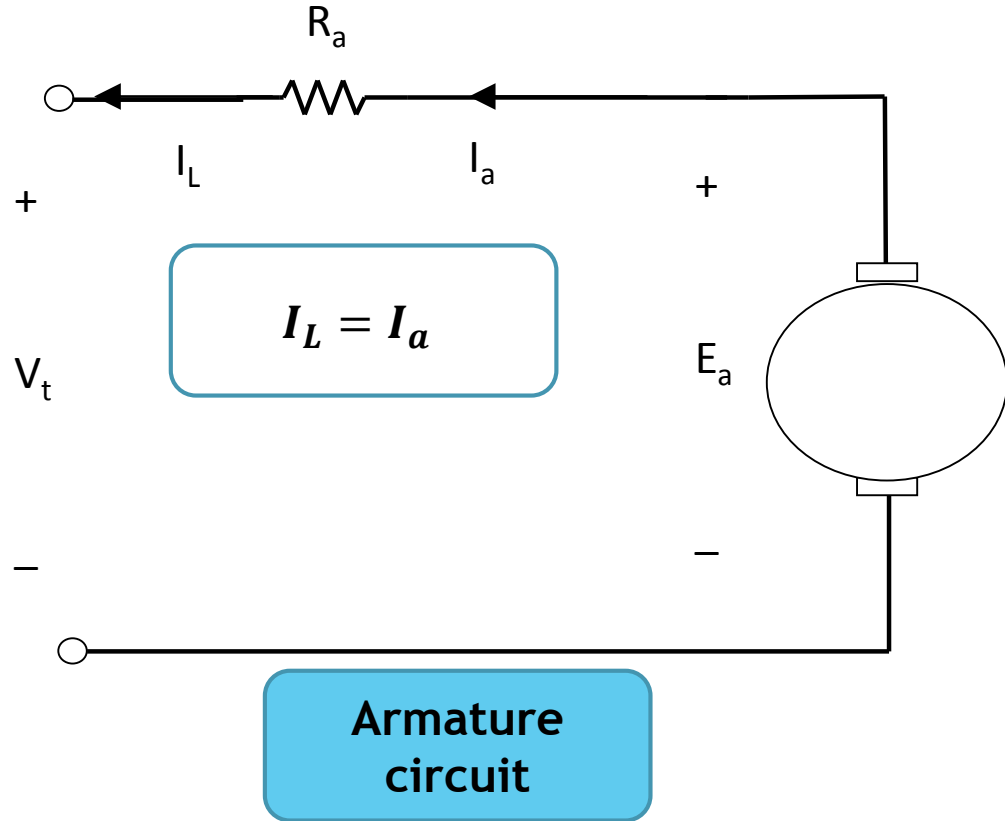

$$E_a = \frac{P}{a} \times \frac{n}{60} \times Z \times \phi \Rightarrow E_a = k\phi\omega$$

$$E_a = V_t + I_a R_a$$

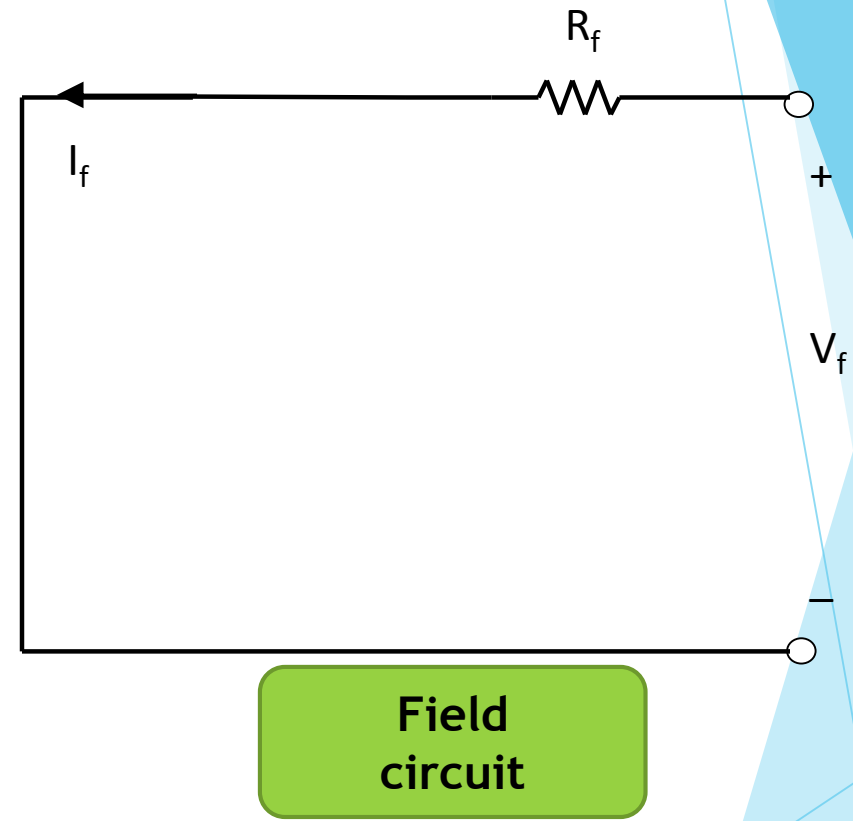

$$I_f = \frac{V_f}{R_f}$$

DC generator Connections:

Magnetization curve of a DC machine

- ❑ The internal generated voltage E_a is directly proportional to the flux in the machine and the speed of its rotation.
- ❑ The field current in a DC machine produces a field mmf $= N_f I_f$, which produces a flux in the machine according to the magnetization curve (BH curve of which the material of the stator has been constructed).

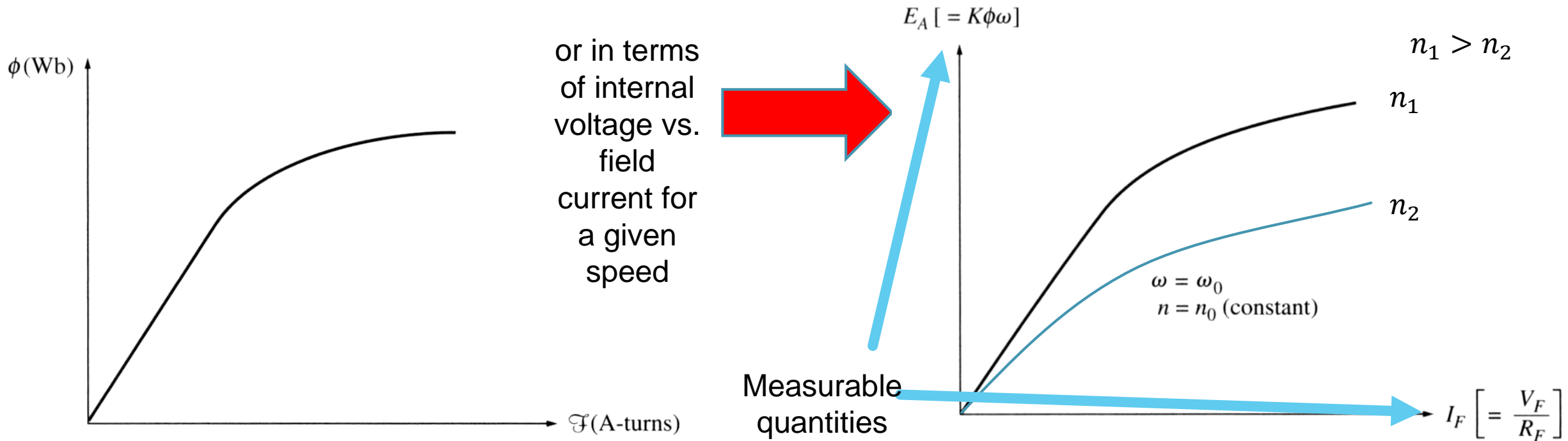

At speed n_1 , since the speed is fixed, then the armature voltage varies with the field current

$$E_a = k_1 \phi$$

DC generator Connections:

Magnetization curve of a DC machine

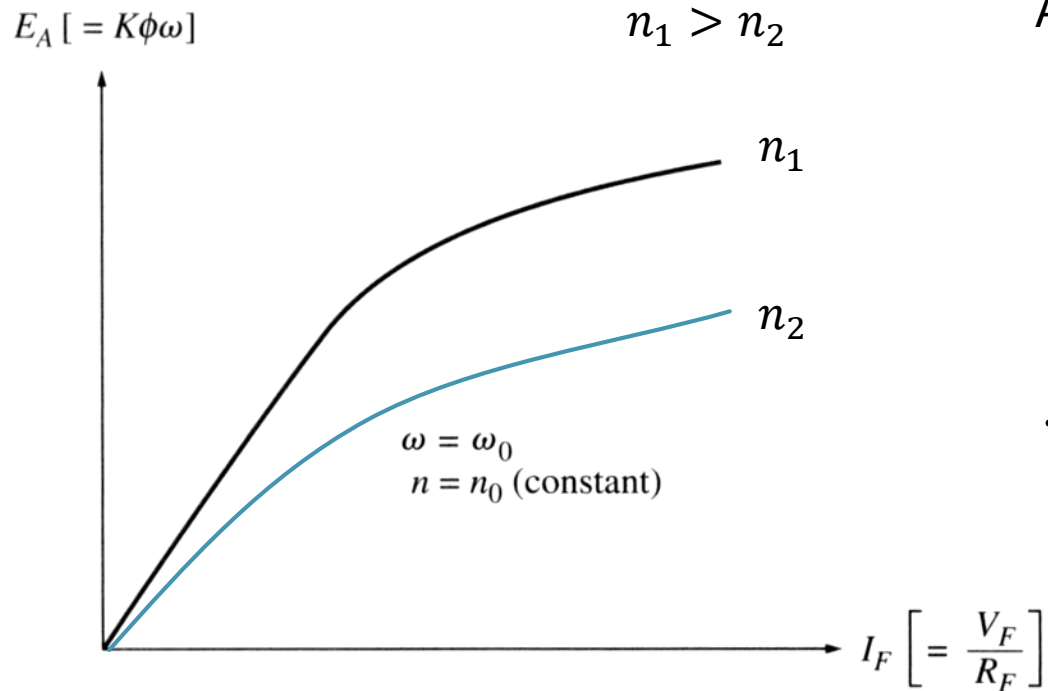

At speed n_1 :

$$E_a = k_1 \phi, k_1 = k\omega \quad \because \phi = k_f I_f$$

$$\therefore E_a = k_1 k_f I_f$$

$$\therefore E_a = V_t + I_a R_a$$



At no-load, the armature current is almost zero, and at this point, the terminal voltage will be equal to the induced voltage. Induced voltage is therefore sometimes called “no-load voltage” which is the voltage measured at the terminals of the machine when the machine is NOT loaded

E_a versus I_f relation is normally referred as “internal characteristics” or magnetizing characteristics or no-load characteristics” as it shows the relation between the internal voltage in the machine versus the field current

DC generator Connections: Separately Excited DC Generator

Magnetization curve of a DC machine

Normally the no-load characteristics don't start from zero, due to the residual magnetism present from the previous operation of the machine

Since the induced emf is directly proportional to the armature speed, we can plot the magnetization curve at any speed by making use of the magnetization curve at the rated speed.

$$E_{a_2} = E_{a_1} \frac{n_2}{n_1}$$

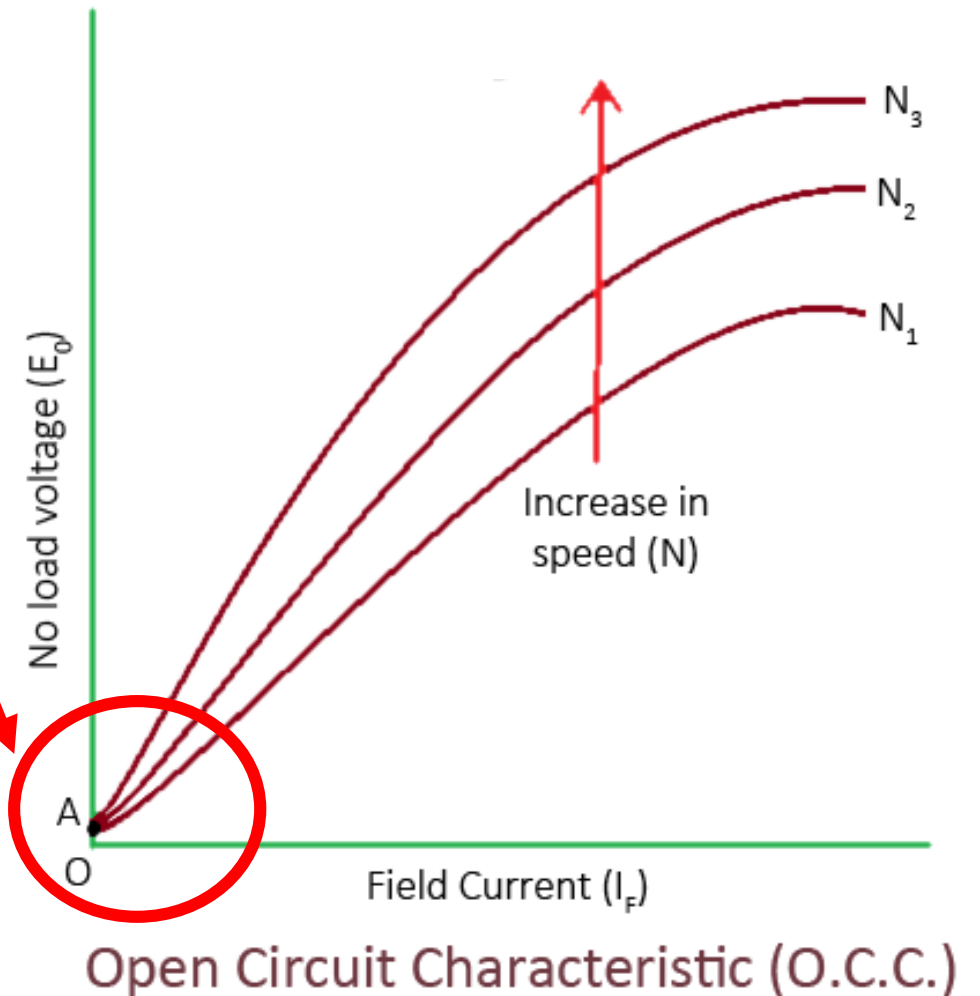

DC generator Connections: Separately Excited DC Generator

Terminal (external) Characteristics

- ❑ The terminal characteristics of a device is a plot of the output quantities of the device versus each other.
- ❑ Unlike the no-load characteristics, the terminal (external) characteristics describe the relation between the machine's output quantities when loaded

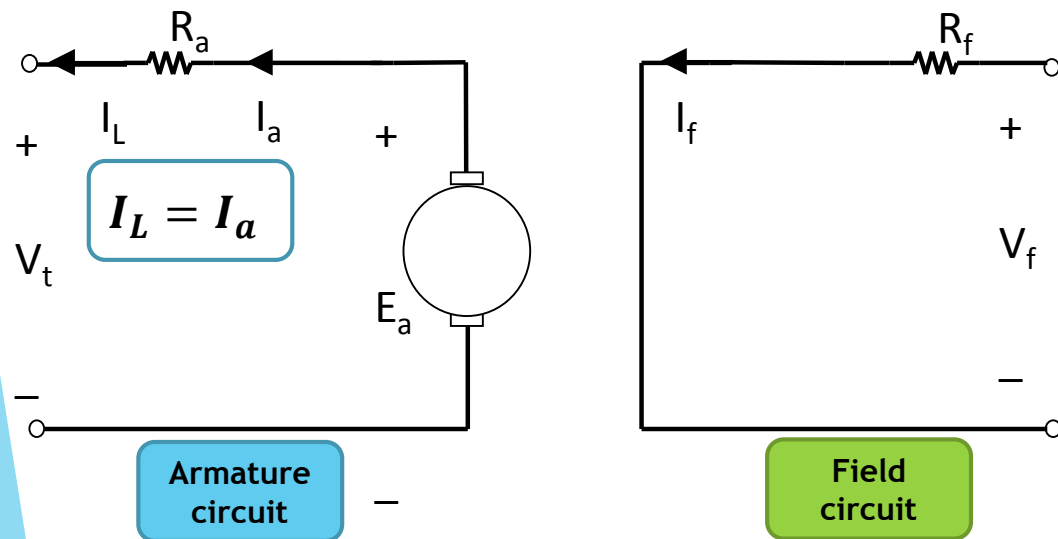

$$\therefore E_a = V_t + I_a R_a$$

$$\therefore V_t = E_a - I_a R_a$$

- ❑ When the field current is held constant and the armature is rotating at a constant speed, the induced emf in an ideal generator is independent of the armature current.
- ❑ As the load current I_a , increases, the terminal voltage V_t , decreases. In the absence of the armature reaction, the decrease in V_t , should be linear and equal to the voltage drop across R_a .

DC generator Connections: Separately Excited DC Generator

Terminal (external) Characteristics

$$\therefore E_a = V_t + I_a R_a$$

$$\therefore V_t = E_a - I_a R_a$$

This implies that the sep. excited generator voltage drops slightly when heavily loaded. What shall be done to keep the terminal voltage constant?????

- 1) Increase the generator speed to increase the induced voltage
- 2) Increase the field current to increase the induced voltage

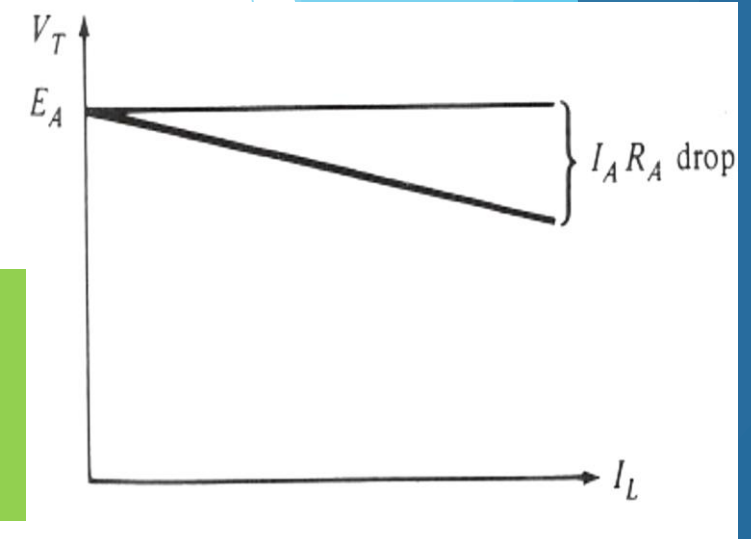

A separately excited dc generator with compensating windings

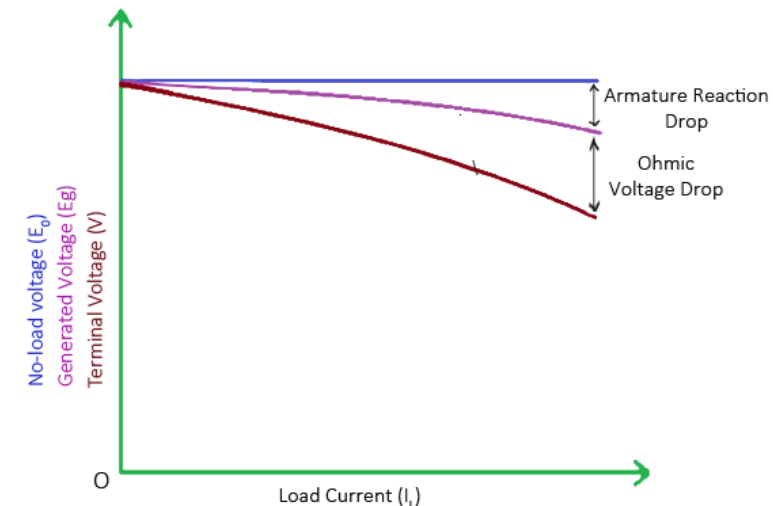

DC generator Connections: Self excited- Shunt Generator

A shunt dc generator is a dc generator that supplies its own field current by having its field connected directly across the terminals of the machine

$$I_L \neq I_a$$

$$E_a = \frac{P}{a} \times \frac{n}{60} \times Z \times \phi \Rightarrow E_a = k\phi\omega$$

$$I_f = \frac{V_f}{R_f}$$

$$E_a = V_t + I_a R_a$$

$$\therefore V_t = E_a - I_a R_a$$

$$I_a = I_L + I_f$$

At no-load, the load current is almost zero, and at this point, the armature current is equal to the field current

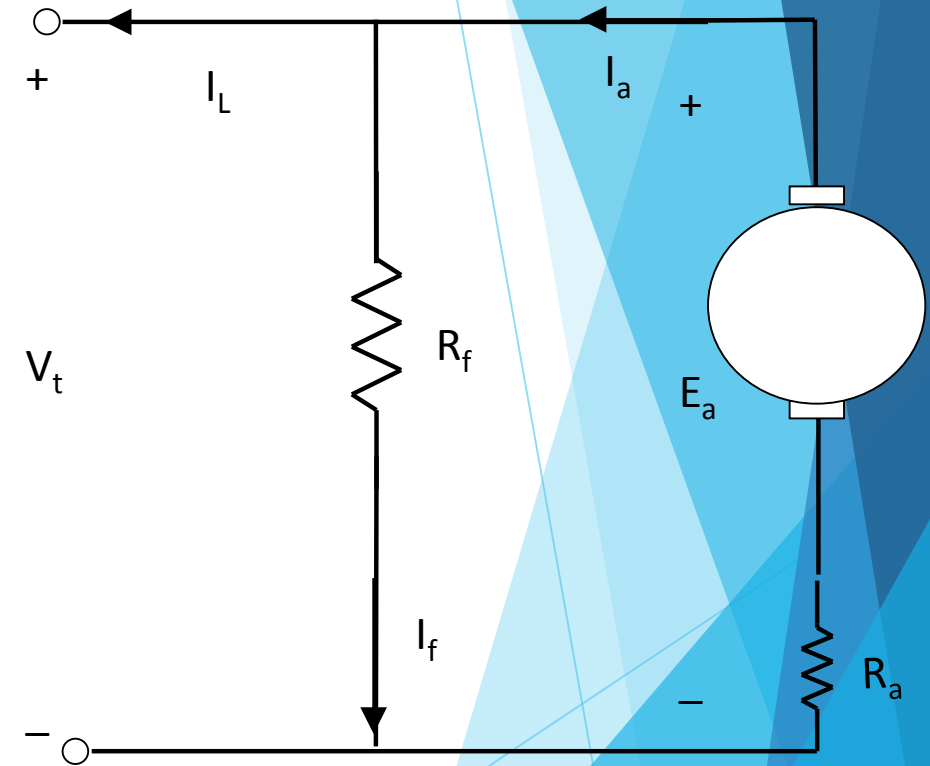

Terminal voltage is the same as the field voltage

DC generator Connections: Self excited- Shunt Generator

$$E_a = V_t + I_a R_a$$

$$I_a = I_L + I_f$$

$$\therefore V_t = E_a - I_a R_a$$

- ❑ Since terminal voltage is applied to the field winding which is sometimes very high, the value of field resistance R_f is chosen to be high to limit the field current value and minimize the power loss in the field circuit. Since The field current is small, the cross sectional area of the field windings are small.
- ❑ On the other hand, armature circuit carries most of the current, so resistance must be small to reduce power loss. Windings have large cross section to tolerate the high current value

In shunt dc machines,

- ❖ field windings are fine and have high resistance value
- ❖ Armature windings are thick and low resistance value

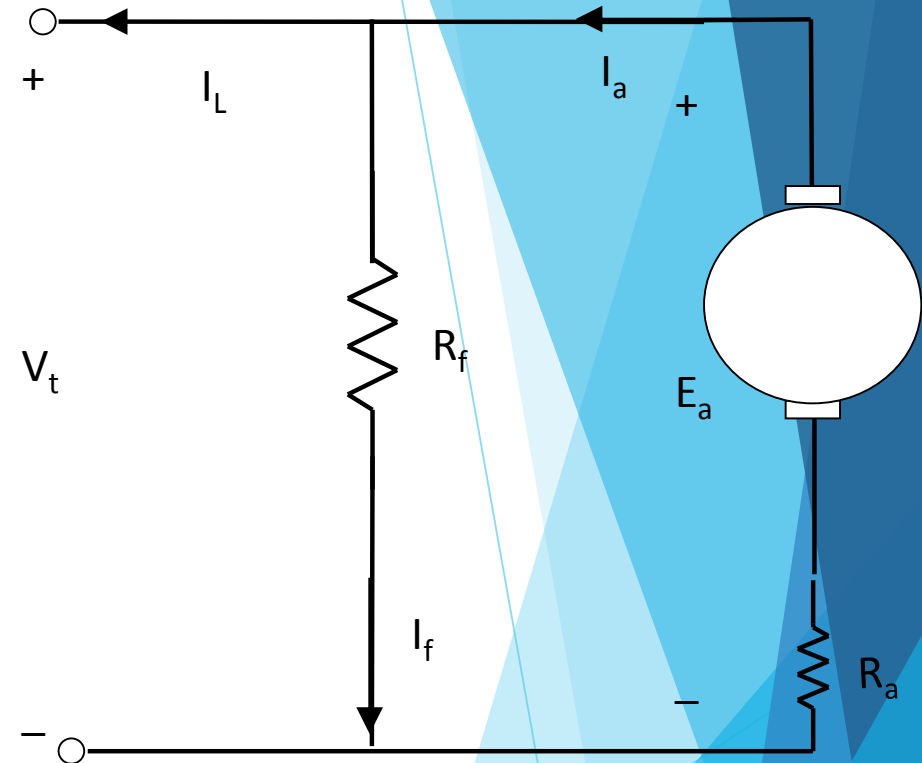

DC generator Connections: Self excited- Shunt Generator

Magnetization curve of a shunt generator

- ❑ As long as some residual flux remains in the field poles, the shunt generator is capable of building up the terminal voltage V_t .
- ❑ When the generator is rotating at its rated speed, the residual flux in the field poles, however small it may be (but it must be there), induces E_a , in the armature winding.
- ❑ Because the field winding is connected across the armature, the E_a sends a small current through the field winding. If the field winding is properly connected, its mmf sets up a flux that aids the residual flux. The total flux per pole increases. The increase in the flux per pole increases E_a which, in turn, increases I_f . The action is therefore cumulative.

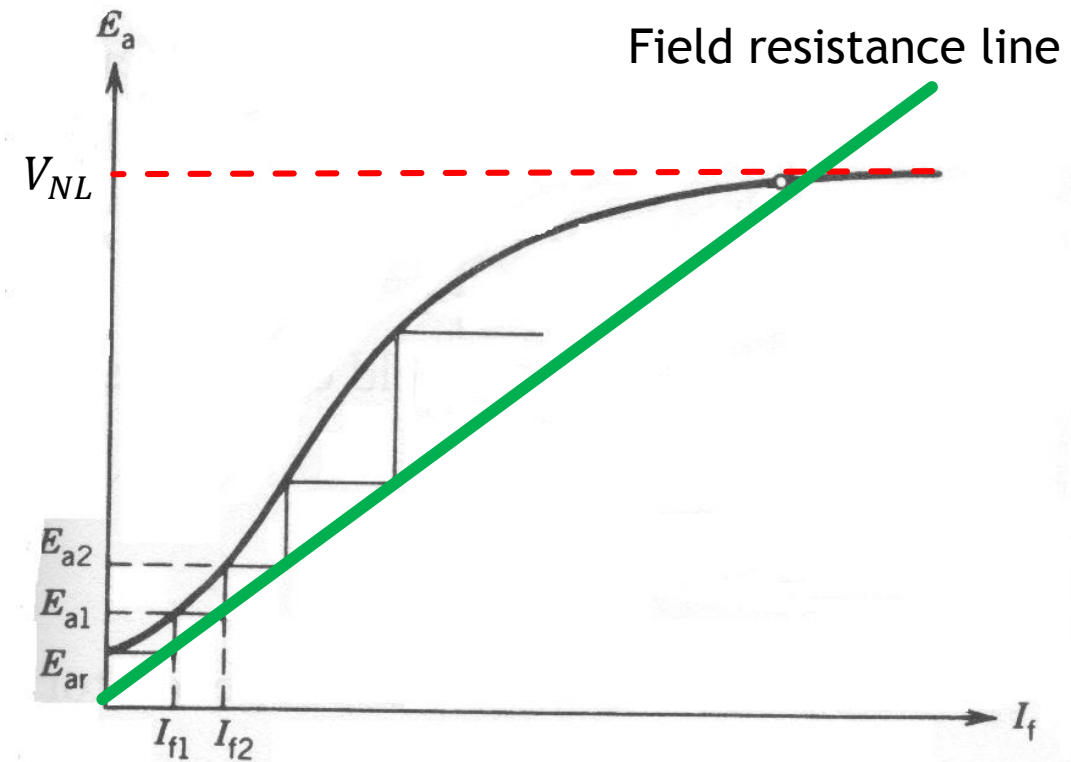

Does this action continue forever? The answer, of course, is no

DC generator Connections: Self excited- Shunt Generator

Magnetization curve of a shunt generator

- E_a follows the nonlinear magnetization curve and I_f depends upon R_f
- The relation between I_f and V_t is linear, and the slope of the curve is R_f . The straight line is also known as the field-resistance line. The shunt generator continues to build up voltage until the point of intersection of the field-resistance line and the magnetic saturation curve. This voltage is known as the no-load voltage.
- It is very important to realize that the saturation of the magnetic material is a blessing in the case of a self-excited generator. Otherwise, the voltage buildup would continue indefinitely.

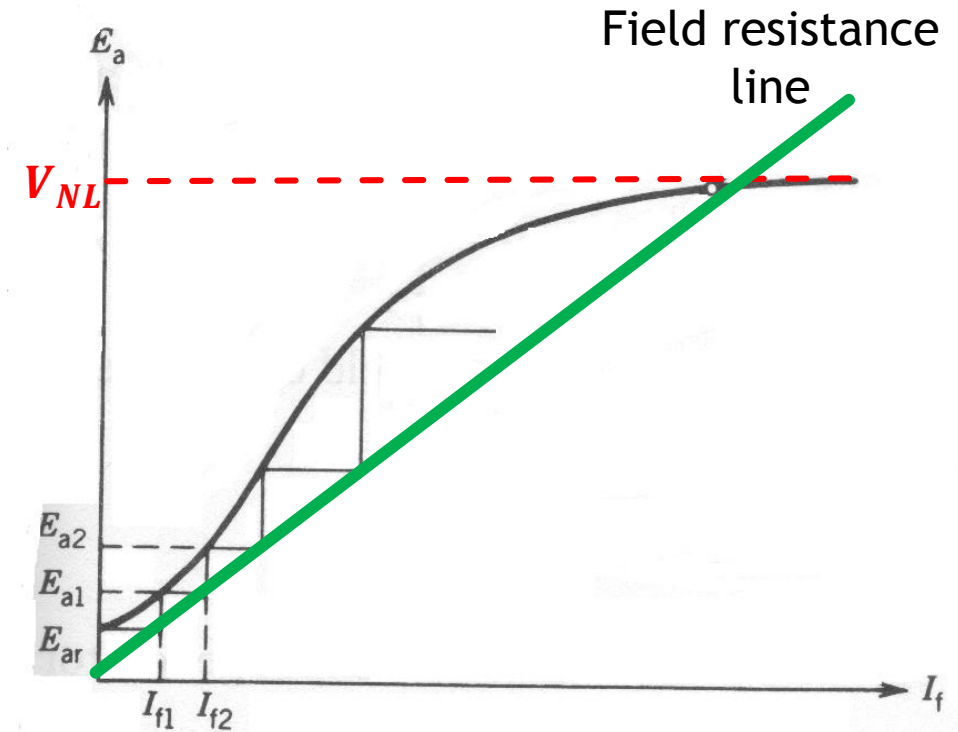

DC generator Connections: Self excited- Shunt Generator

Magnetization curve of a shunt generator

- ❑ The value of V_{NL} at the armature terminals depends upon R_f . A decrease in the R_f causes the shunt generator to build up to a higher voltage.
- ❑ The value of the R_f that makes the field-resistance line tangent to the magnetization curve is called the critical (field) resistance $R_{f\text{critical}}$. The generator voltage will not build up if the R_f is greater than or equal to $R_{f\text{critical}}$.
- ❑ The speed at which the field circuit resistance becomes $R_{f\text{critical}}$ is called the critical speed n_{critical} .

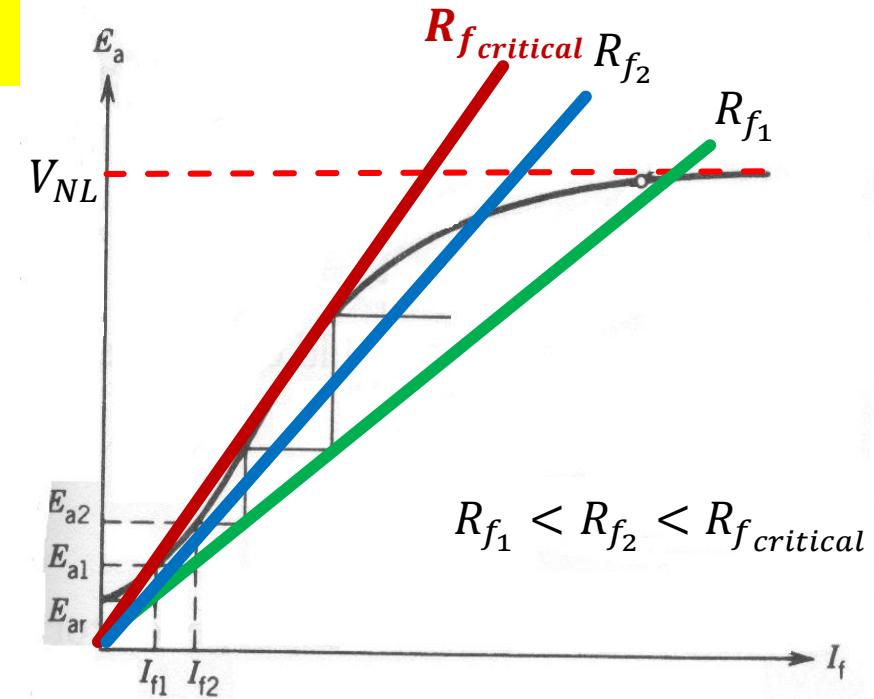

Voltage buildup in a shunt generator:

- a residual flux exists in the field poles,
- the field-winding mmf produces the flux that aids the residual flux,
- the field-circuit resistance is less than the critical resistance.

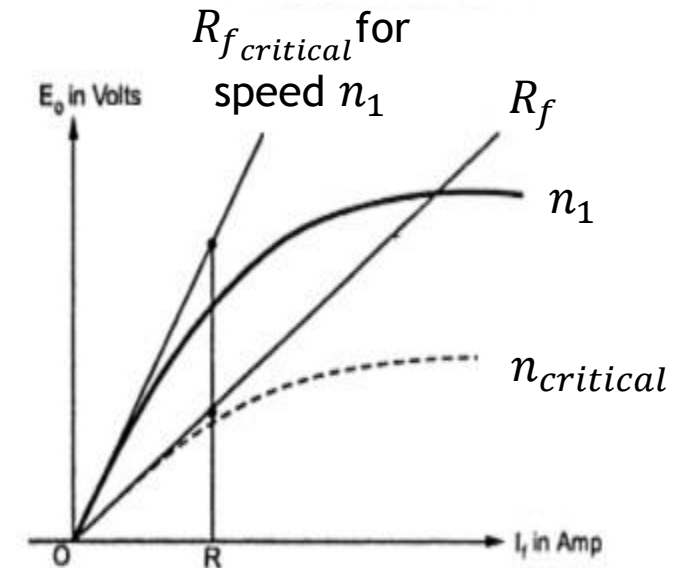

DC generator Connections: Self excited- Shunt Generator

Terminal (external) Characteristics

$$I_a = I_L + I_f \quad V_t = E_a - I_a R_a$$

At no load, I_a is equal to I_f , which is usually a small fraction of the load current I_L . Therefore, V_{NL} is **nearly** equal to E_a as $I_a R_a$ is small

As I_L increases, V_t decreases for the following reasons:

- The increase in $I_a R_a$ drop
- The demagnetization effect of the armature reaction
- The decrease in the field current due to the drop in the induced emf

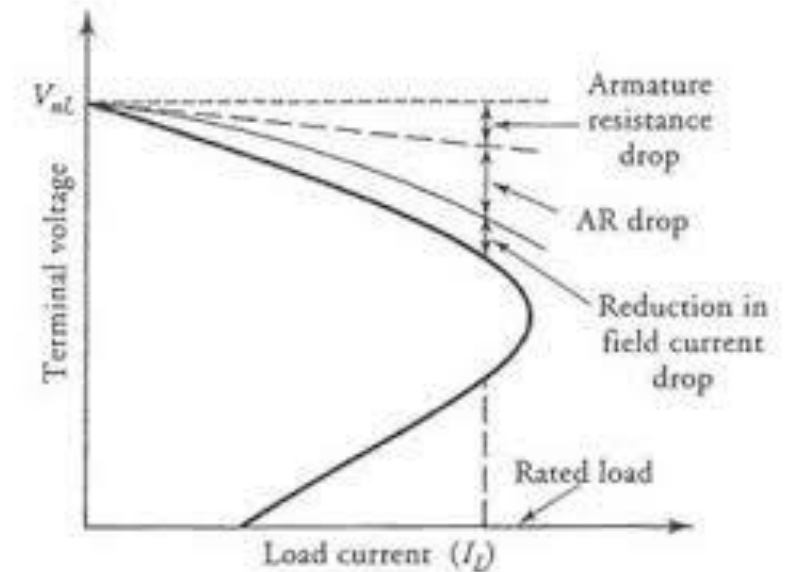

$I_L \uparrow, \therefore (I_a = I_f + I_L) \uparrow, \therefore I_a R_a \uparrow, \therefore (V_t \downarrow = E_a - I_a R_a \uparrow)$ \rightarrow Till here, this is almost the same behavior as separately excited generator

BUT $V_t \downarrow, I_f \downarrow, \varphi \downarrow, E_a \downarrow, V_t \downarrow\downarrow$ \rightarrow More drop compared to the separately excited generator!

DC generator Connections: Self excited- Shunt Generator

Terminal (external) Characteristics

This implies that the shunt generator voltage drops when heavily loaded. What shall be done to keep the terminal voltage constant?????

- 1) Increase the generator speed to increase the induced voltage
- 2) Increase the field resistor thus change the field current

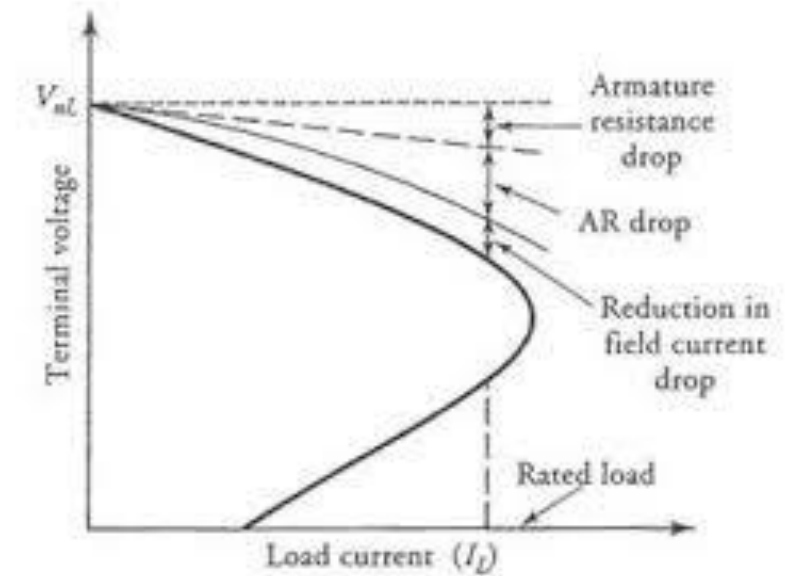

DC generator Connections: Self excited- Series Generator

- The field winding of a series generator is connected in series with the armature and the external circuit. Because the series field winding has to carry the rated load current, it usually has few turns of heavy wire.

$$E_a = V_t + I_a(R_a + R_f)$$

$$\therefore V_t = E_a - I_a(R_a + R_f)$$

$$I_a = I_L = I_f$$

$$E_a = \frac{P}{a} \times \frac{n}{60} \times Z \times \phi \Rightarrow E_a = k\phi\omega$$

- When the generator is operating under no load, the flux produced by the series field winding is zero. Therefore, the terminal voltage of the generator is equal to the induced emf due to the residual flux. As soon as the generator supplies a load current, the mmf of the series field winding produces a flux that aids the residual flux. Therefore, the induced emf, in the armature winding is higher when the generator delivers power than that at no load (E at load is higher than e at no load).

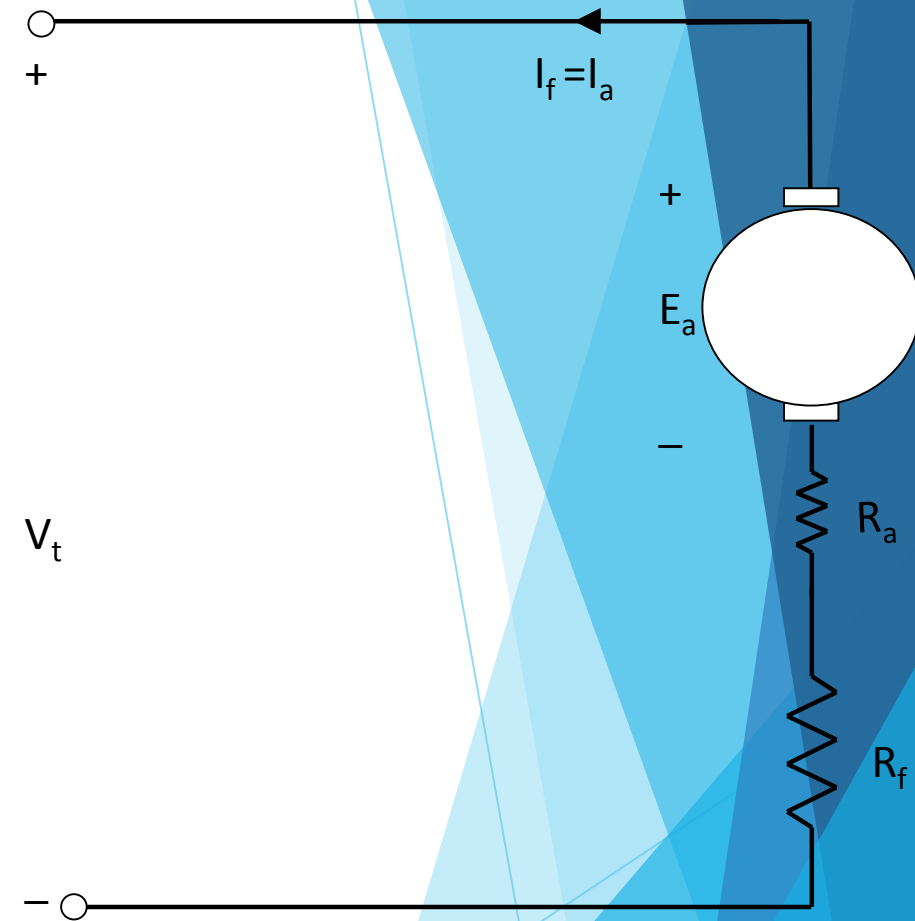

DC generator Connections: Self excited- Series Generator

Magnetic and Terminal Characteristics

- When the generator is operating under no load, there is no field current so V_t is reduced to a small level given by the residual flux in the machine.
- As the load increases, the field current rises, E_a rises rapidly. The $I_a(R_a + R_f)$ drop goes up too, but at first the increase in E_a goes up more rapidly than the $I_a(R_a + R_f)$ drop rises, so that V_t increases.
- When machine reaches saturation, E_a stops rising and the $I_a(R_a + R_f)$ drop is the dominant effect

$$E_a \uparrow\uparrow = V_t + I_a \uparrow (R_a + R_f)$$

$$\therefore V_t \uparrow = E_a \uparrow\uparrow - I_a \uparrow (R_a + R_f)$$

$$I_a = I_L = I_f$$

$$E_a = \frac{P}{a} \times \frac{n}{60} \times Z \times \phi \rightarrow E_a = k\phi\omega$$

Not so popular in use as it is a bad constant-voltage source

Characteristics are “sharper” than shunt due to the ohmic drop. It is often called voltage booster

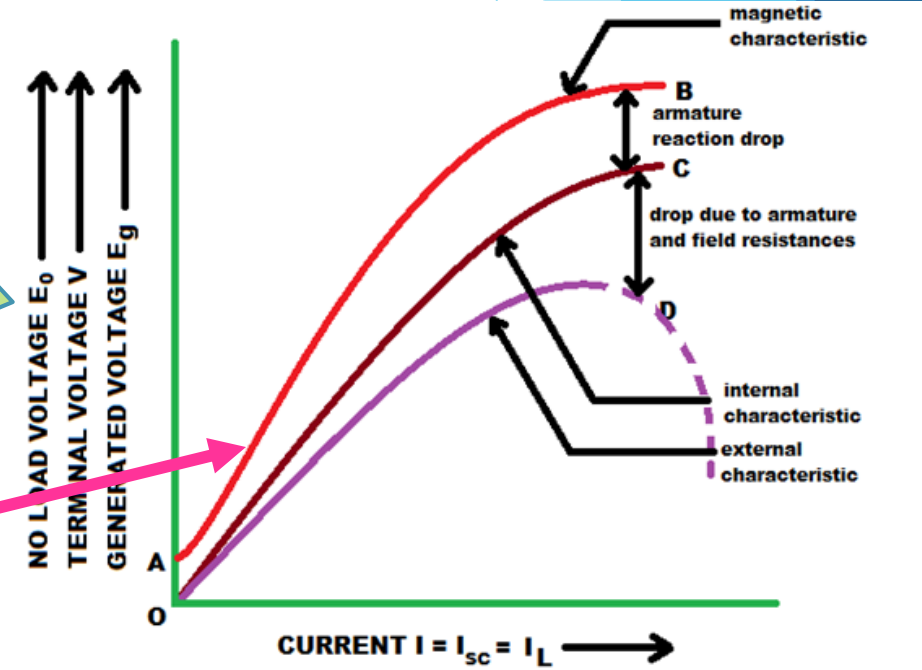

CHARACTERISTIC CURVES OF SERIES WOUND DC GENERATORS

Losses and Efficiency in DC generator

1- Mechanical losses:

- friction between bearings and shaft
- Friction between brushes and commutator
- Windage losses (the drag on the armature cause by the air enveloping the armature)

2- Core losses: **ALREADY DISCUSSED IN LECTURE 2**

- Hysteresis
- Eddy currents

BOTH are often called rotational losses. Also they might be called “no-load losses” as they are INDEPENDENT on load

3- Copper losses: current flows in a wire, a copper loss is associated with it. The copper losses, also known as electrical or I^2R losses, are:

1. Armature-winding loss
2. Shunt field-winding loss
3. Series field-winding loss
4. Interpole field-winding loss
5. Compensating field-winding loss

Losses and Efficiency in DC generator

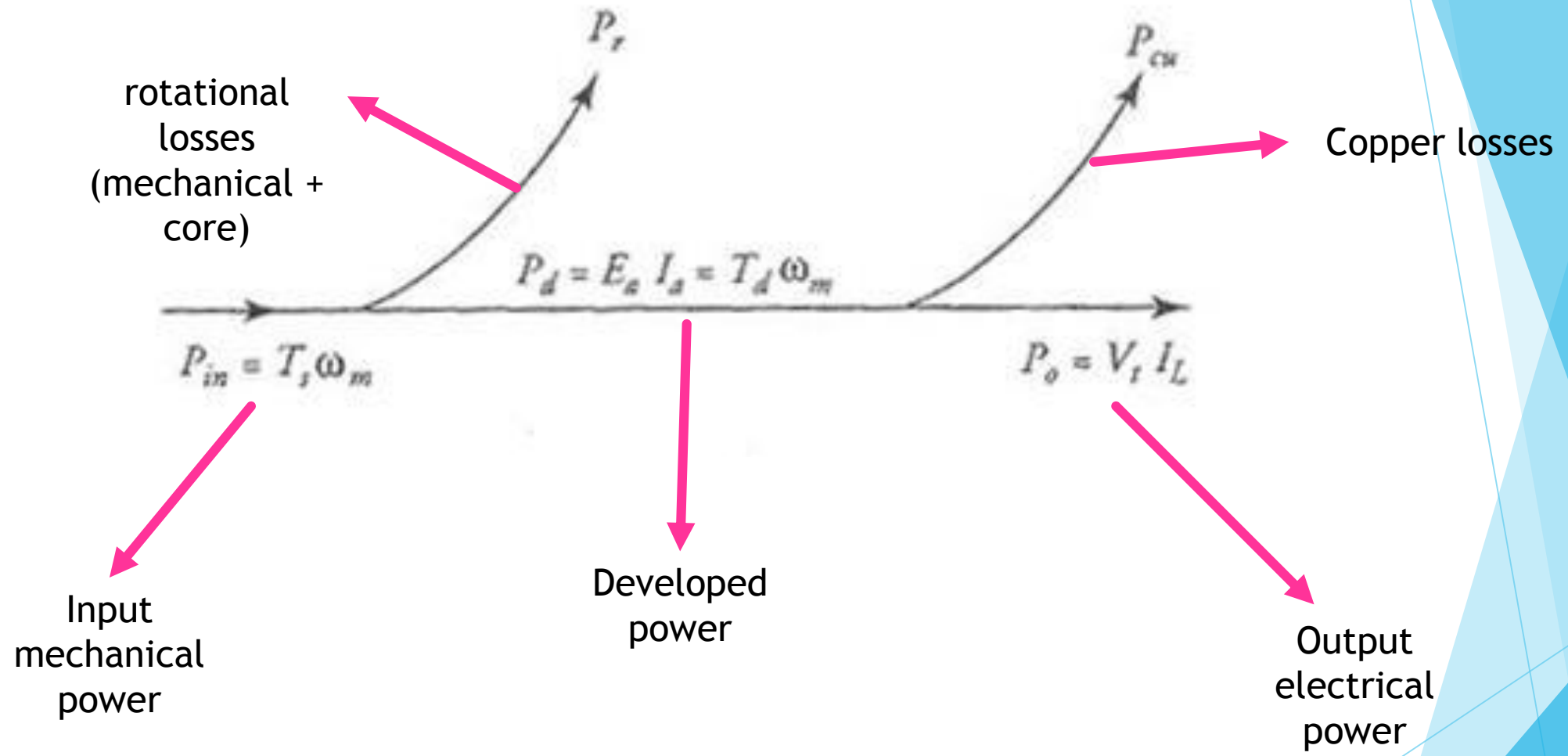

Questions

Explain the working principle of dc generator indicating how alternating emf is generated in armature windings

Explain the types of connections of dc generators

Plot the magnetization characteristics and terminal characteristics of the following generators:

a- shunt generator

b- separately excited

c- series excited

Explain how dc shunt generators build up voltage

What is meant by critical field resistance and critical speed?

How to maintain the terminal voltage of dc generators with loading?

How is the field winding structure of shunt and series generators are different?