

Stabilized Power AC-DC-AC Converter using polygon transformer

Dr. Mona F. Moussa*, Eng. Nermeen Biomy**, Prof. Yasser G. Dessouky

Dept. of Elec. & Control Eng, Arab Academy for Science and Technology, AASTMT, Alexandria

P.O. Box: 1029 Egypt

* mona.moussa@yahoo.com

** nbiomy@gmail.com

Abstract-Static power converters are used for many applications, like frequency converters for motors, uninterruptible power supplies (UPS's), general power supplies. This paper analyses the performance of high power static 400Hz supply system used in aircraft ground power units. However, the problem of this system is the harmonics coming from the load current towards the supply. This problem can be overcome by using a way to improve the supply wave. One of those is using novel polygon transformer.

This paper presents combining of stabilized power AC-DC-AC supply using polygon transformer to improve the supply wave and using a passive filter on the output load. The design and simulation of this system has been presented.

In [8], the polygon transformer is connected to achieve 18-pulse AC-DC conversion through phase shifting between the two sets of voltages equal 20° with respect to the supply voltage. The disadvantage of this connection is that realizing feasible values for the tapping portion for step up operation is not possible. Therefore, in the proposed system, a novel idea for the 18 pulse conversion is achieved by phase shifting between voltage sets with 40° .

Keywords- Stabilizing power AC-DC-AC converter, Power quality, Polygon autotransformer, Harmonics elimination.

I. INTRODUCTION

The AC power system harmonic problems are mainly due to the substantial increase of non-linear loads due to technological advances, such as the use of power electronics circuits and devices. These loads draw non-sinusoidal currents from electrical power systems which pass through different impedances in the power systems and produce voltage harmonics. These voltage harmonics propagate in power systems and affect all of the power system components [1].

In recent years considerable effort was aimed at achieving control methods that can maintain a very low THD in presence of non-linear load for critical applications. One such example is the 400Hz inverter used in aircraft applications, also known as ground power unit (GPU) [2]. Since they are used to provide power to the aircraft prior to take-off or after landing, these inverters are subject to strict requirements [3].

The 400-Hz inverters are widely used as the power supply for airplanes, ships, radar and many other types of equipment. As the power rating has always been increasing, 400-Hz high power inverters are in great demand.

In today aircraft industry, electrical aircrafts are increasingly employed to achieve better efficiency, cost reduction and better performance [1-4]. As a result, the number of electrical loads equipped on-board is increasing and the on board power capacity is getting larger. However, most of the DC loads are typically supplied by the uncontrolled diode rectifier converters, causing the power quality problem in the aircraft power system. The high harmonic current distortion and poor power factor would be a major concern when the percentage of total system power processed by uncontrolled rectifiers is high [5].

General problems of harmonics on power systems are presented in more KVAR is drawn from the electrical network leading to poor PF and sudden increase in KVA demand causing power factor penalties, reduced system capacity and increase in energy losses (because harmonics create additional heat, transformers and other distribution equipment cannot carry full rated load) decreasing the system efficiency, excessive temperature rise, vibration, audible noise, protective device malfunction, flickering lights, data corruption and increased maintenance problem (failure of capacitors, contactors) [1].

The bridge rectifier suffers from operating problems [4],[5] such as poor power factor, injection of harmonic currents into the ac mains, equipment overheating due to harmonic current absorption, low rectifier efficiency, input ac mains voltage distortion and malfunction of sensitive electronic equipments etc. In order to prevent the harmonics from affecting the utility lines negatively, an IEEE Standard 519 [6] has been established in 1981 and reissued in 1992 as the "Recommended Practices and Requirements for Harmonic Control in Electrical Power System" giving limits on voltage distortion. Several methods based on the principle of increasing the number of rectification pulses in ac-dc converters have been reported in the literature [7-8], which are simple to implement. These methods use two or more converters, where the harmonics generated by one converter are cancelled by other converter, by proper phase shift. The

conventional wye-delta transformer based 12-pulse rectification scheme is one such example [9-14].

Harmonics can be cancelled either at the supply side or at the load side. At the supply side active filters and the polygon autotransformer connection are used while at the load side, parallel-series resonant filter, trap filters and also passive filters are used. Different wave shaping techniques have been reported in the literature for power quality improvement [15], [16]. The active wave shaping techniques result in power quality improvement, but these need fast digital processors along with the complex circuits. The transformer is designed to step up the voltage.

In this paper, we focus at the supply side. The ac-dc-ac converter used results in nearly unity power factor operation in the wide operating range. This approach results in the following advantages [17]:

- 1) Compact, simple, rugged and reliable converter configuration.
- 2) A retrofit solution, which improves utilization of the bridge rectifier.
- 3) THD of ac mains current and power factor are improved even under light load conditions.

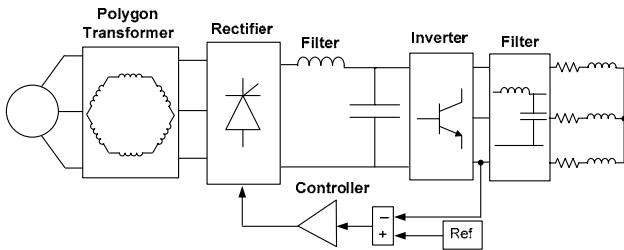

Fig. 1. Proposed autotransformer based 18-pulse ac-dc-ac converter.

The polygon autotransformer with a novel connection is used to cancel the supply harmonics, while 3-three phase rectifiers are connected to the output of the polygon autotransformer, then a filter acts as a DC link connected to the inverter to the load and a feedback is comparing the load voltage with a reference value then the PI controller in order to stabilize the load wave [18].

II. DESIGN OF AUTOTRANSFORMER FOR PROPOSED 18-PULSE AC-DC CONVERTER

The minimum phase shift required for proper harmonic elimination is given by [8]: \therefore Phase shift = 60° /Number of six-pulse converters. For achieving 18-pulse ac-dc conversion, the phase shift between the two sets of voltages should be of 40 with respect to the supply voltages.

The transformer is designed to step up the voltage by 140% to produce 440 V output from 380 V supply and to compensate the losses which occur according to voltage drop in the cable impedance. From the supply voltages, three sets of three-phase voltages (phase shifted through

$+40^\circ$ and -40°) are produced. The number of turns required for $+40^\circ$ and -40° phase shift are calculated. Fig. 2(a) shows the winding connection of this autotransformer. Fig.2(b) shows the corresponding phasor diagram of different phase voltages. Consider phase "a" voltages in Fig. 2(a) as:

$$V_{a1} = V_a + K_1 V_c - K_2 V_b \quad (1)$$

$$V_{a3} = V_a + K_1 V_b - K_2 V_c \quad (2)$$

$$V_{a2} = V_a + K_3 V_a \quad (3)$$

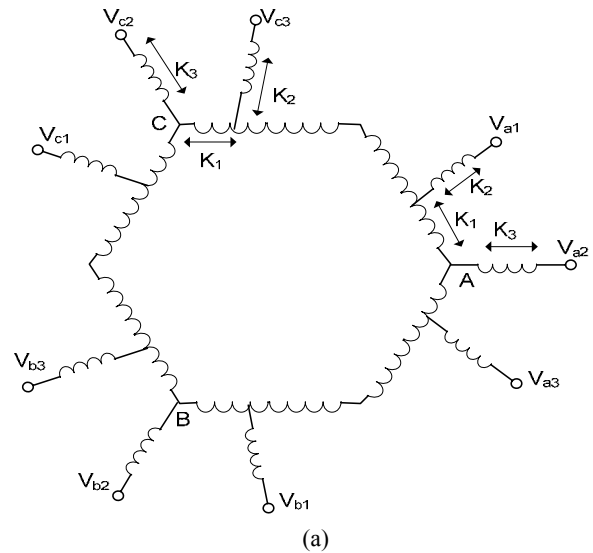

(a)

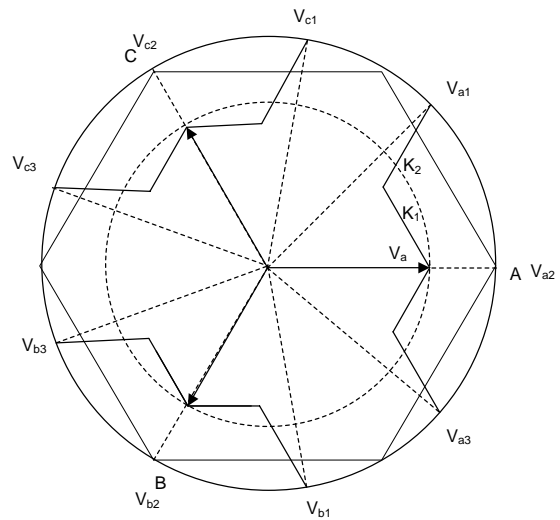

(b)

Fig. 2. (a) Winding connection diagram. (b) Phasor diagram of different phase voltages in autotransformer based 18-pulse

Assume the following set of voltages:

$$V_c = V \angle 0^\circ, V_b = V \angle -120^\circ, V_a = V \angle 120^\circ \quad (4)$$

$$V_{c1} = 1.4V \angle 40^\circ, V_{b1} = 1.4V \angle -80^\circ, V_{c2} = 1.4V \angle 160^\circ \quad (5)$$

Similarly

$$V_{c3} = 1.4V \angle 20^\circ, V_{b3} = 1.4V \angle -120^\circ, V_{c4} = 1.4V \angle 120^\circ \quad (6)$$

$$V_{c5} = 1.4V \angle -40^\circ, V_{b5} = 2V \angle -160^\circ, V_{c6} = 2V \angle 80^\circ \quad (7)$$

Where V_a , V_b , and V_c are phase voltages of the input supply and V is the r.m.s of phase voltage.

Using the above equations K_1 , K_2 , and K_3 can be calculated. These equations result in $K_1 = 0.44688$, $K_2 = 0.59656$, and $K_3 = 0.4$ for the desired phase shift in autotransformer.

A phase shifted voltage (e.g., V_{a1}) is obtained by tapping a portion (0.44688) of phase voltage V_c and connecting one end of an approximately (0.59656) of phase voltage (e.g., V_b) to this tap. Thus the autotransformer can be designed with these known values of winding constants, i.e., K_1 , K_2 , and K_3 .

III. SIMULATION

A 10KW prototype system is used to simulate the proposed system using MATLAB software as shown in Fig. 3, where it consists of 3-phase supply (380V, 50Hz) connected to three single-phase step up autotransformer connected to produce 18 pulses based phase shifted voltages, as shown in Fig. 4, whose outputs are connected to three phase controlled rectifiers, then to interphase transformers which provides isolation between rectifiers and DC link in the right side. An LC filter is used to smooth dc link which is connected to a 3-phase RL load with a first order passive LC filter through the inverter (440V, 400Hz). The load voltage is compared with a reference voltage then the output is connected to PI controller feeding back the bridge rectifiers. The results are shown in Fig. 5 to Fig. 9.

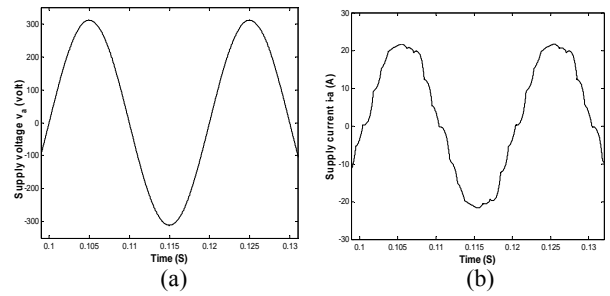

Fig. 5. The input supply voltage and current at full load.

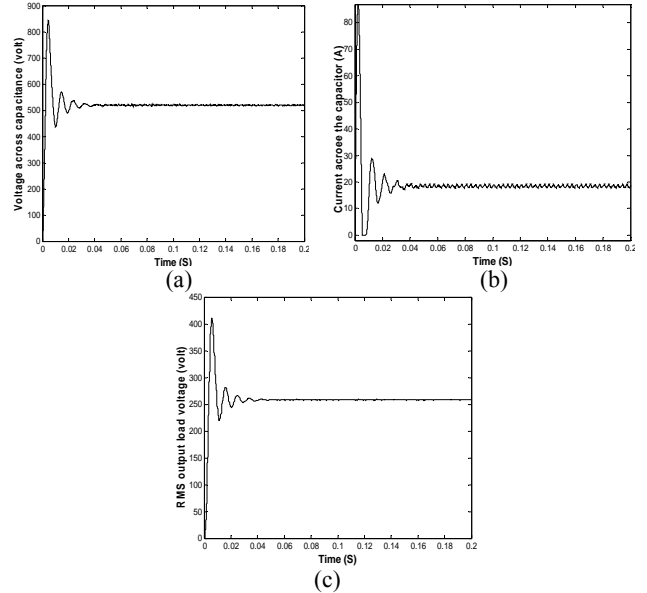

Fig. 6. Voltage across capacitor, current through capacitor, and RMS output load voltage.

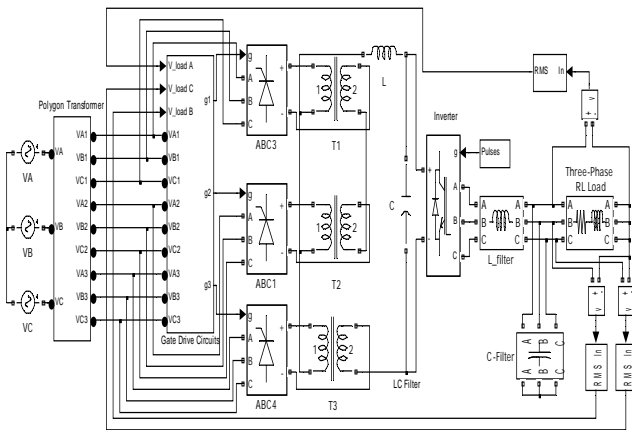

Fig. 3. Simulink diagram of the overall system.

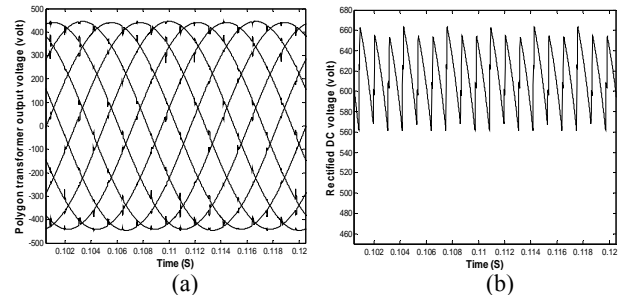

Fig. 7. Polygon transformer voltage, and rectified DC voltage.

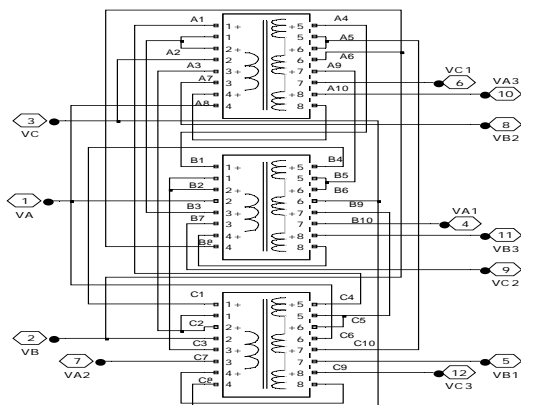
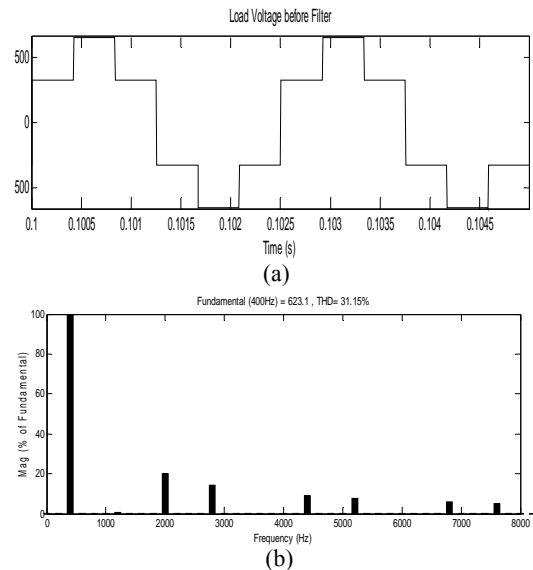
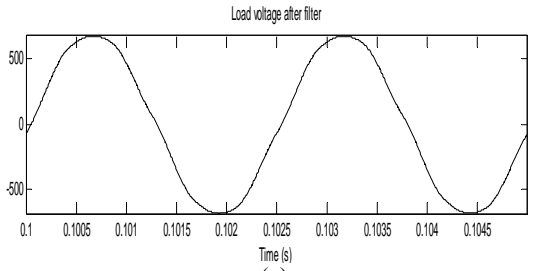

Fig. 4. Simulink diagram of the proposed autotransformer.



(b)



(c)

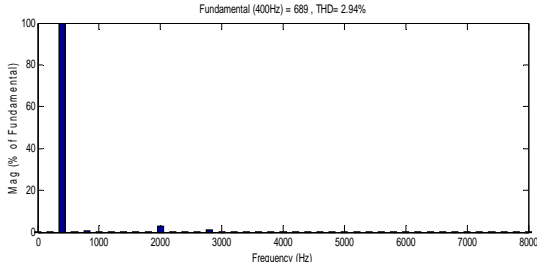

(d)

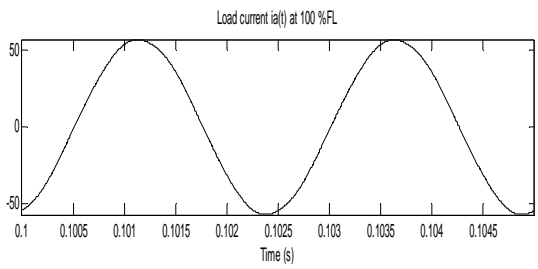

(e)

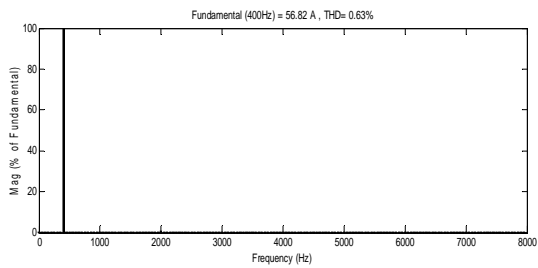

(f)

Fig. 8. Instantaneous wave form and FFT for the load voltage before filter, load voltage after filter, and load current.

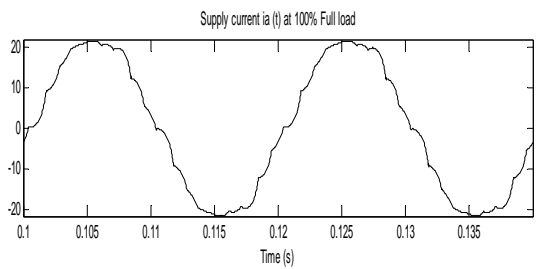

(a)

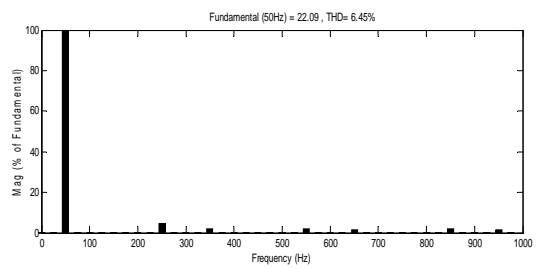

(b)

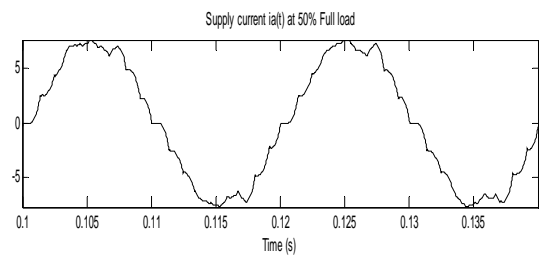

(c)

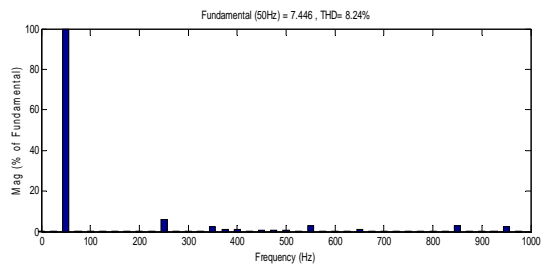

(d)

Fig. 9. Instantaneous supply current wave form and FFT at 100% FL and 50% FL for the proposed system.

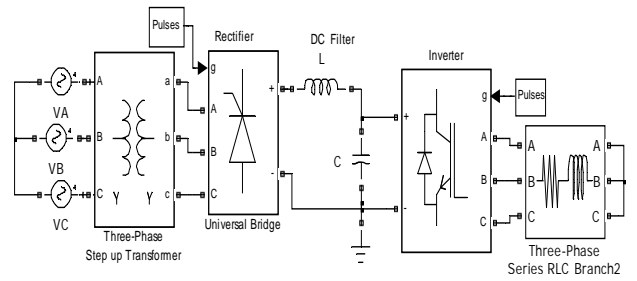
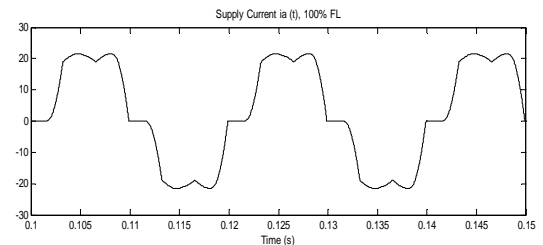
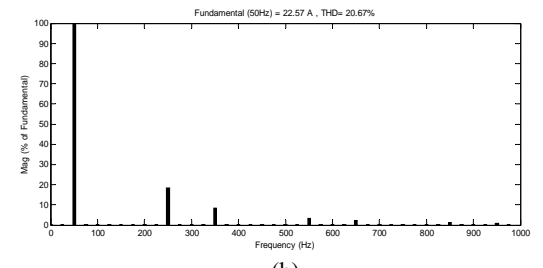

Fig. 10. Simulink diagram of the conventional step up transformer.



(a)



(b)

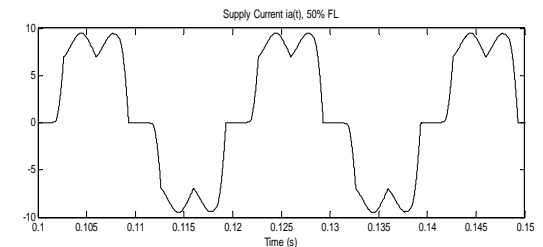

(c)

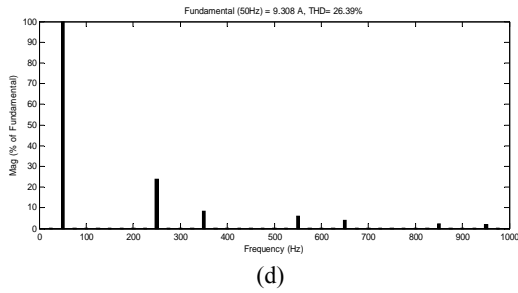

Fig. 11. Instantaneous supply current wave form and FFT at 100% FL and 50% FL for the conventional system.

IV. DISCUSSION

- In [8], the polygon transformer is connected to achieve 18-pulse AC-DC conversion through phase shifting between the two sets of voltages equal 20° with respect to the supply voltage. The disadvantage of this connection is that realizing feasible values for the tapping portion K_1 and K_2 for step up operation is not possible. Therefore, in the proposed system, the 18 pulse conversion is achieved by phase shifting between voltage sets with 40° . This should give the possibility of realizing the tapping ratios K_1 and K_2 for step up operation as shown in equations (5) to (7) with the same action as for as the production of 18 pulse is concerned as shown in Fig. 7(a).
- The polygon auto-transformer used in the novel proposed system uses three transformers each of which has eight coils wound in a symmetrical construction shape, as shown in Fig. 12, such that each side has four coils where
 - The two tapping portions K_1 are obtained from coils (1) and (5), and
 - the 100% winding is obtained by connecting coils (1) & (2) in and (5) & (6) in series, and
 - the two tapping portions K_2 are obtained from coils (3) and (7), and
 - the tapping portion K_3 is obtained by connecting coils (4) & (8) in anti-series.
- From the simulation, it is concluded that, at full load:
 - The three-phase Y-connected input supply is ($V_L = 380V$, $I_L = 22A$) with a phase difference of 10° .
 - The DC voltage is ($V_{dc} = \frac{3\sqrt{3}V_{max}}{\pi} \cos \alpha$), where $\cos \alpha = 0.758$ and $V_{dc} = 519.28V$ and the DC current = 18A.
 - The 3-phase Y-connected output voltage is ($V_L = 440V$, 58.8A).
- From Fig. 8 (c) and (e), it is shown that the output factor is $\cos 68^\circ \cong 0.3$ while the input power factor is $\cos 10^\circ \cong 0.98$ at full load (see Fig. 5 (a) and (b)). The same improvement is noticed at 50% full load which proves that this proposed system improves the system power factor.

- From Fig. 9 (b) and (d) it is shown that the input supply current has a THD of 6% at full load. It is noticed that the THD is 8% at 50% full load. This proved that the proposed system improves the THD in the input supply current.
- From Fig. 8 (c) and (e), it is shown that the output load voltage and current are sinusoidal at full load with THD of (3%) and (0.2%) respectively. This is suitable for (440V, 400Hz) aircraft applications.
- Fig. 7 (a) shows the shape of the 9-voltages for the three 3-phase voltage groups, where it is noticed that the voltages have not distorted but balanced sinusoidal shape at full load (20A). This is also noticed at 50% of full load.
- The output voltage before the filter is shown in Fig 8 (a) is the conventional 3-phase 180° conduction voltage whose FFT is given in Fig. 8 (b), where the fundamental 400Hz component is 623volt. The output filter is designed at a cut off frequency of 1KHz and therefore output voltage after the filter shown in Fig. 8 (c) is almost sinusoidal with THD of 3%.
- The size of the filter of the DC link has the advantage of being relatively small ($L = 25$ mH, $C = 47\mu F$) because of the effect of the polygon transformer which achieves 18 pulses per cycle that when rectified produces considerably good DC voltage.
- The size of the filter of the output load has the advantage of being relatively small ($L = 2.5$ mH, $C = 10\mu F$) because of the high output frequency (400 Hz), which means the succeeding harmonics is the ($5^{th} = 2000$ Hz). This allows designing the filter at a cut off frequency of 1 KHz.

$$f_c = \frac{1}{2\pi\sqrt{LC}} \cong 1000 \text{ Hz}$$
- The proposed system in Fig. 3 is compared with a conventional system as shown in Fig. 10 which consists of a 3-phase ($V_L=380V$, $f=50Hz$) connected to a Y-Y connection (1:1.4) step up three phase transformer then to a 3-phase controlled bridge rectifier. The same value of the DC link filter ($L = 25$ mH, $C = 47\mu F$), as the proposed system, is to feed the same load through a three phase inverter. Comparing the two systems together, it is concluded that the proposed system has the advantages of:
 - Lower THD for the input supply current.
 - Higher displacement power factor.
 - Smaller size for the DC link filter although this proposed system has the disadvantage of using interphase transformer for isolation.

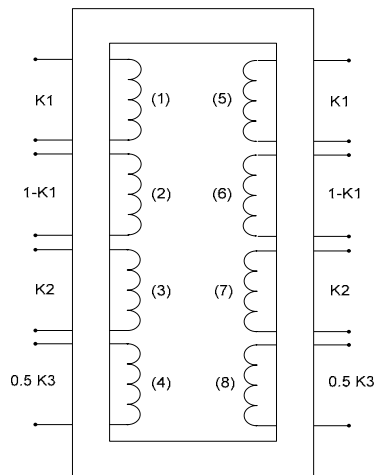

Fig. 12. Transformer Connection.

V. CONCLUSION

A high performance static power supply is designed. The proposed 18-pulse AC-DC converter has resulted in reduction in rating of the magnetic. Meanwhile, a good dynamic response and steady-state performance are provided by the presented method.

Simulations were carried out in order to test the performance of the proposed static power supply.

There has been considerable improvement in the total harmonic distortion of AC main currents as well as the power factor (with almost close to unity power factor in the wide operating range).

REFERENCES

- [1] Liviu Mihalache, "Voltage Amplitude Regulation Method For Paralleling 400 Hz GPU Inverters Without Intercommunication Signals", Applied Power Electronics Conf. and exposition 24th annual IEEE, PP, 1608-1614, 2009.
- [2] F. Gao, P. Wang, Y. Li, and H. Zixin, "Wireless Parallel Operation of 400-Hz High-Power Inverters in Ground Power Units for Airplanes", 14th International Power Electronics and Motion Control Conference, EPE-PEMC, PP, 165-171, 2010.
- [3] R. Redl, P. Tenti, and J. D. Van Wyk, "Power electronics polluting effects," IEEE Spectrum, vol. 34, no. 5, pp. 32–39, May 1997.
- [4] D. D. Shipp and W. S. Vilcheck, "Power quality and line considerations for variable speed ac drives," IEEE Trans. Ind. Appl., vol. 32, no. 2, pp. 403–409, Mar./Apr. 1996.

- [5] IEEE Guide for Harmonic Control and Reactive Compensation of Static Power Converters, IEEE std. 519-1992.
- [6] D. A. Paice, "Power Electronic Converter Harmonics: Multipulse Methods for Clean Power," New York: IEEE Press, 1996.
- [7] H. Jaehong, K. Moonshik, P. N. Enjeti, and I. J. Pitel, "Analysis and design of harmonic subtractors for three phase rectifier equipment to meet harmonic compliance," in Proc. IEEE APEC'00, vol.1, pp. 211–217, Feb. 2000.
- [8] B. Singh, G. Bhuvaneswari, and V. Grag, "A Novel Polygon Based 18-Pulse AC–DC Converter for Vector Controlled Induction Motor Drives", IEEE Transactions on Power Electronics, vol. 22, no. 2, March 2007.
- [9] Li, Zixin, Li Yaohua, Wang Ping, Gao Fanqiang, Zhao Lu, "The inner current-loop in double-loop digital control of 400 Hz inverter based power supply under low switching frequency condition," International Conf. on Electrical Machines and Systems (ICEM), 2010.
- [10] K. J. Astrom, and T. Haggglund, "PID Controllers: Theory, Design, and Tuning," Instrument Soc. Amer., Research Triangle Park, NC, 1995
- [11] J. G. Ziegler and N. B. Nichols, "Optimum settings for automatic controllers," Trans. ASME, vol. 64, pp. 759-768, 1942.
- [12] C. C. Hang, K. J. Astrom, and W. K. Ho, "Refinements of the Ziegler-Nichols tuning formula," IEE Proceedings-D, vol. 138, no. 2, pp, 111-118, 1991.
- [13] T. Siong, B. Ismail, M. F. Mohammed, M. Tajuddin, S. R. Abd. Rahim, Z. M. Isa, "Study of fuzzy and PI Controller for permanent magnet brushless DC motor drive," 4th international power engineering and optimization Conf. (PEOCO2010), Malaysia, June, 2010.
- [14] P. Vas, "Sensorless Vector and Direct Torque Control," Oxford, U.K.: Oxford Univ. Press, 1998.
- [15] F. J. M. de Seixas and I. Barbi, "A12 kW three-phase low THD rectifier with high frequency isolation and regulated dc output," IEEE Trans. Power Electron., vol. 19, no. 2, pp. 371–377, Mar. 2004.
- [16] V. Garg, "Power Quality Improvements at ac Mains in Variable Frequency Induction Motor Drives," Ph.D. dissertation, Indian Inst. Technol. Delhi, NewDelhi, 2006.
- [17] H. Hu, W. Shi, J. Xue, Y. Lu, Y. Xing, "A Multi-resolution control strategy for DSP controlled 400Hz shunt active power filter in an aircraft power system," 25th annual IEEE, Applied power electronics conference and exposition (APEC), 2010.
- [18] S. E. Joung, B. G. Park, I. H. Cha, "An improved synchronization control scheme of a low cost 400 Hz power supply for no-break power transfer," 7th International Conf. on power electronics, 2007.